

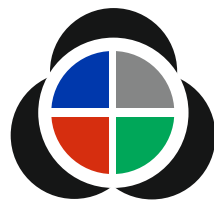

# User Manual





# testifire®

MULTI-STIMULUS DETECTOR TESTER

## User Manual

This manual provides information for the correct use of the **testifire®** 1000 and 2000 series of detector testers including:

Testifire® 1000 Head Unit  
Testifire® 100I Testing Kit  
Testifire® 600I Testing Kit  
Testifire® 900I Testing Kit

Testifire® 2000 Head Unit  
Testifire® 200I Testing Kit  
Testifire® 620I Testing Kit  
Testifire® 920I Testing Kit

### Replacement Capsules

TS3 Smoke Capsule  
TC3 CO Capsule

### Additional Items

Solo™ 760 Battery Baton™  
Solo™ 726 Universal Fast Battery Charger  
Solo™ 100 Telescope Pole  
Solo™ 101 Extension Pole  
Solo™ 200 Universal Detector Removal Tool  
Solo™ 610 Protective Carrying / Storage Bag  
Testifire® 25 Infrared Remote Control  
Testifire® 100 RFID Bluetooth® Module\*

A complete Product Selector of the Testifire components and kits is shown on page 36 of this User Manual.

For any additional information or technical support, please contact your local distributor, or visit the Testifire web site at: [www.testifire.com](http://www.testifire.com)

\* Future option

Testifire 2000 illustrated



## detectortesters





testing technology from No Climb

## Important Information



- **Read this User Manual completely before using your Testifire.**
- **Save this User Manual** - Save all safety and operational instructions for future reference.
- **Take note of the Warnings** - Read carefully and follow all warning labels on the product and those described in this User Manual.
- **Water and Moisture** - This product is designed for indoor use only and should not be subject to, or used in, a wet environment.
- **Servicing** - To make sure that your Testifire unit continues to perform as intended, it will require a regular service. A standard period for service is every 12 months. In extreme use, a service could be required sooner. Testifire has a built-in service interval timer and it will warn you when a service is due or overdue. (See section 7.5 for more information).
- Testifire is a precision electronic instrument and care should be taken when handling and storing. Dropping on to a hard surface could damage it. Please look after it, treat it with care and it will last for many years.
- To protect the high-precision technology contained in Testifire, never leave Testifire in the places listed below, whether if in use or in storage:
  - Places where temperatures and/or humidity are high or go through extreme changes. Direct sunlight, or near other heat sources (stoves, radiators, etc.) Always observe the operating and storage environment restrictions detailed in the Technical Specifications (see Section 9)
  - In sandy or dusty environments.
  - In places prone to strong vibration.
  - Near to sources of static or radio waves.
  - Wet or moist environments. Testifire is designed for indoor use only.
- Stop using Testifire immediately if you notice any unusual odours; liquids or noise coming from it. Switch off immediately and consult technical support (section 7.1).
- If your Testifire unit becomes damaged do not use it. Switch off immediately and consult technical support (section 7.1).
- Testifire is not designed for use in hazardous areas (those containing explosive vapour or dust).
- Use only approved accessories that are recommended by the manufacturer for your Testifire model.
- The Battery Baton should be removed when Testifire is not in use. This will prevent the gradual discharge of the battery and prevent possible accidental operation of the head unit.
- Do not use your Testifire if it is not operating properly. Consult the Troubleshooting section (section 6.0) of this manual and if required seek technical advice.
- If the equipment is used in a manner not specified by the manufacturer, the protection provided by the equipment may be impaired.
- Use only approved accessories that are recommended by the manufacturer for your Testifire model. (see Section 9.1)

## Meanings of Symbols and Terms

The following symbols are used throughout this User Manual.

	<p>This symbol on the product indicates that there is a safety hazard.</p> <p>You must read the appropriate sections of the User Manual to understand the nature and severity of all the potential hazards present and the action you must take.</p>
	<p>This symbol on the product indicates that you should read and understand this User Manual before using this product.</p>
	<p>This symbol on the product warns you of hot surfaces or heat by convection.</p>
	<p>This symbol on the product indicates that this part of the device is susceptible to static damage.</p>
	<p>The crossed-out refuse container symbol on this product or literature indicates that it should not be disposed with other business waste at the end of its working life. To help ensure that valuable resources are reused and recycled, and to prevent possible harm to the environment or human health from uncontrolled waste disposal, please separate this from any other types of waste.</p>

## General Safety Information

	<p><b>CAUTION</b></p> <p>This product is intended to be used at height.</p> <p>Exercise great care and always wear appropriate PPE (personal protective equipment) when operating above head height in order to avoid the risk of injury.</p> <p><b>DO NOT OVER REACH.</b> Keep proper footing and balance at all times. Proper footing and balance enables better control of the equipment in unexpected situations.</p> <p>Pay particular attention to avoid contact with overhead items such as light fittings, overhead power cables/busbars and any other objects that could be accidentally dislodged which might cause danger to the operator or anyone else in the vicinity.</p>
	<p><b>CAUTION</b></p> <p>This product contains hot surfaces and hot air is also emitted from the duct outlet.</p> <p><b>DO NOT TOUCH</b> the tip of the CO capsule when it has been removed if the unit has been in operation within the previous 5 minutes. It will be very hot immediately after use and may burn if touched.</p> <p><b>DO NOT</b> insert fingers into the aperture from where the CO capsule has been removed. There are very hot surfaces which may burn if touched.</p> <p>Avoid placing hands near the duct outlet during heat testing or within 5 minutes of conducting heat testing.</p> <p>Hot air is emitted from the duct and the top of the duct will get hot to the touch.</p>
	<p><b>WARNING</b></p> <p>This product emits small amounts of carbon monoxide (CO) gas which is a harmful, odourless gas.</p> <p><b>DO NOT INHALE</b> directly from the duct during a CO test or within 5 minutes of conducting a CO test.</p> <p>Note: Under normal operating conditions, this emission will present no harm to the user. For additional information please refer to the separate safety information provided.</p>

# Table of Contents

	Page No.
<b>1. <u>General Instructions</u></b>	<b>4</b>
1.1 Warranty	4
1.2 Acknowledgement	4
1.3 Recycling	4
<b>2. <u>Introduction</u></b>	<b>5</b>
<b>3. <u>Parts Identification</u></b>	<b>6</b>
<b>4. <u>Preparation For Use</u></b>	<b>7</b>
4.1 Charging the Battery	7
4.2 Using the Battery	8
4.3 Removal and Replacement of the Smoke and Carbon Monoxide (CO) Capsules	9
4.4 Turning the Unit On	10
4.5 Using the Menus	11
4.6 Adjusting the Head Unit Angle	11
4.7 Testing High Profile Detectors	12
<b>5. <u>Using Your Testifire</u></b>	<b>13</b>
5.1 Sounder Option	14
5.2 Testing a Detector	14
5.3 Smoke Testing	15
5.4 Heat Testing	15
5.5 Carbon Monoxide (CO) Testing	17
5.6 Clearing the Detector	17
5.7 Capsule Fuel Level	18
5.8 Simultaneous Testing	19
5.9 Sequential Testing	19
5.10 Combined Simultaneous and Sequential Testing	20
5.11 Infrared Remote Control	20
5.12 RFID Auto Tests*	21
5.13 Indicating LED Reference Chart	22
<b>6. <u>Troubleshooting</u></b>	<b>23</b>
6.1 Errors	23
6.2 System Reset	23
6.3 Error Messages and Indicating LED Reference Chart	24
<b>7. <u>Support</u></b>	<b>25</b>
7.1 Technical Support	25
7.2 Future Updates	25
7.3 System Information	25
7.4 Maintenance	25
7.5 Servicing	26
7.6 Service Reminders	27
7.7 Testifire Flash Loader Software Instructions	28
<b>8. <u>Technical Specifications</u></b>	<b>34</b>
8.1 Field Replaceable Parts	35
<b>9. <u>Product Selector</u></b>	<b>36</b>
<b>10. <u>Agreement for Supply of Products and Associated Software</u></b>	<b>37</b>

\* Future option

# I. General Instructions

## I.1 Warranty

In addition to any other express warranty given in writing by the Company in relation to the Goods, the Company warrants that the Goods supplied under these terms and conditions will be in accordance with the specification (if any) contained in the Purchase Order, and will be free from defects in workmanship and material for a period of 18 months from the date of delivery to the Buyer or for a period of 12 months after the date of sale by the Buyer to the final customer whichever period is the shorter.

## I.2 Acknowledgement

**Testifire<sup>®</sup>, Solo<sup>™</sup> and Battery Baton<sup>™</sup>** are registered marks of **No Climb Products Ltd.** All other brand names mentioned are trademarks or registered marks of their respective holders, and are hereby acknowledged.  
© 2010 No Climb Products Ltd.  
All Rights Reserved.

## I.3 Recycling

The packaging can be easily separated into the following materials:

- Cardboard (outer box)
- Cardboard (inner buffers, boxes)
- Polyethylene (Capsule bags)
- Plastic (Capsule caps)

Please dispose in line with local environmental requirements.

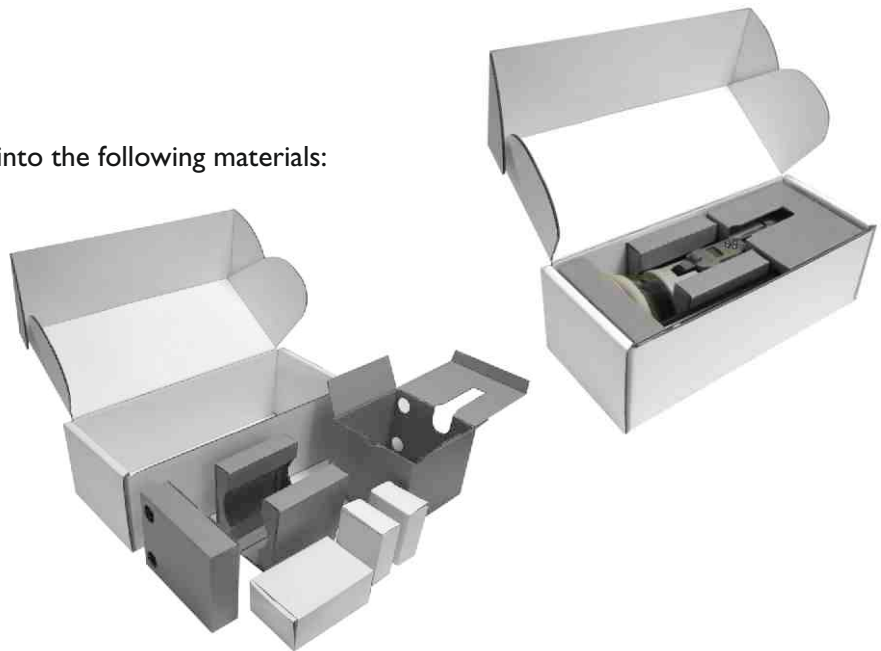

## WEEE (Waste Electrical & Electronic Equipment) Regulations 2006

Testifire and Testifire capsules are suitably marked to be recycled in accordance with your local environmental requirements. Alternatively these items may be returned to the manufacturer via your reseller for disposal in compliance with WEEE (Waste Electrical & Electronic Equipment) Regulations 2006.

## RoHS Declaration

We declare that this product and its associated components are designed and manufactured to be fully compliant with the requirements of the Directive 2002/95/EC Restrictions of use of certain Hazardous Substances in Electrical and Electronic Equipment (The RoHS Directive).

## EULA (End User Licence Agreement)

See Section 10.

## 2. Introduction

### *Thank you for purchasing Testifire Multi-Stimulus Detector Tester.*

This manual is designed to assist you to get the best and most efficient use of the Testifire 1000 and 2000 model range, and provides all the information required to perform routine service and maintenance tasks with ease.

Testifire includes an array of advanced and intelligent technologies that change traditional approaches to functional testing in the field. Simply by being able to test all fire detectors with one unit is faster and more productive. In addition the Testifire range brings health, safety, environmental and technological benefits to field servicing of fire detectors as never seen before.

Testifire is a technologically advanced, fully field portable device for functional testing of fire detectors. The unit is suitable for testing optical/photoelectric and ionisation smoke sensors, thermal sensors (fixed temperature or rate-of-rise), and carbon monoxide (CO) fire sensors, be they conventional, addressable or analogue addressable. Testifire is also the first functional tester that enables testing of multi-sensors or multi-criteria detectors from a single test unit.

Testifire creates stimuli that the sensors are designed to detect. Depending on the model purchased, Testifire can create smoke, heat and CO stimuli on demand from a single unit. Testifire creates stimuli without using pressurised aerosol cans or hazardous media. Stimuli (Smoke, Heat, and CO) are generated at the time of test using safe and patented processes fuelled by replaceable capsules.

Testifire can also execute programmed testing: Simultaneously (any combination of Smoke, Heat and CO), Sequentially (e.g. Smoke, followed by Heat and then CO) or Combined Simultaneous and Sequentially (e.g. Smoke and Heat together followed by CO). In addition it also incorporates a clearing mode that enables the stimuli to be blown out of the detector immediately after a test, enabling more rapid resets at the panel.

Testifire is also capable of reading from, and writing data to electronic RFID tags which may be installed on detectors. This permits a level of automation in testing and logging of service and maintenance activities. The facility for an optional RFID and Bluetooth® module is covered in detail in the RFID manual.

If you require additional information or assistance in the use of Testifire, please visit the support area of our web site, or contact our technical support department as detailed on the Support page of this User Manual.



**Testifire 1000 Series  
Head Unit**

**Testifire 2000 Series  
Head Unit**



### 3. Parts Identification

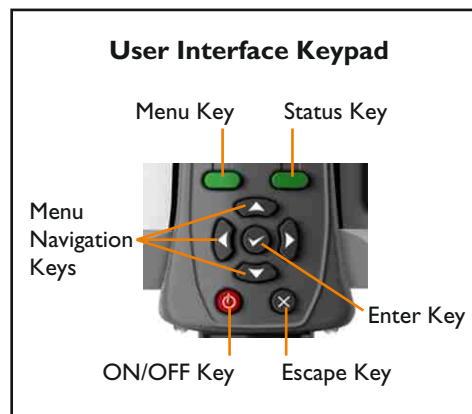
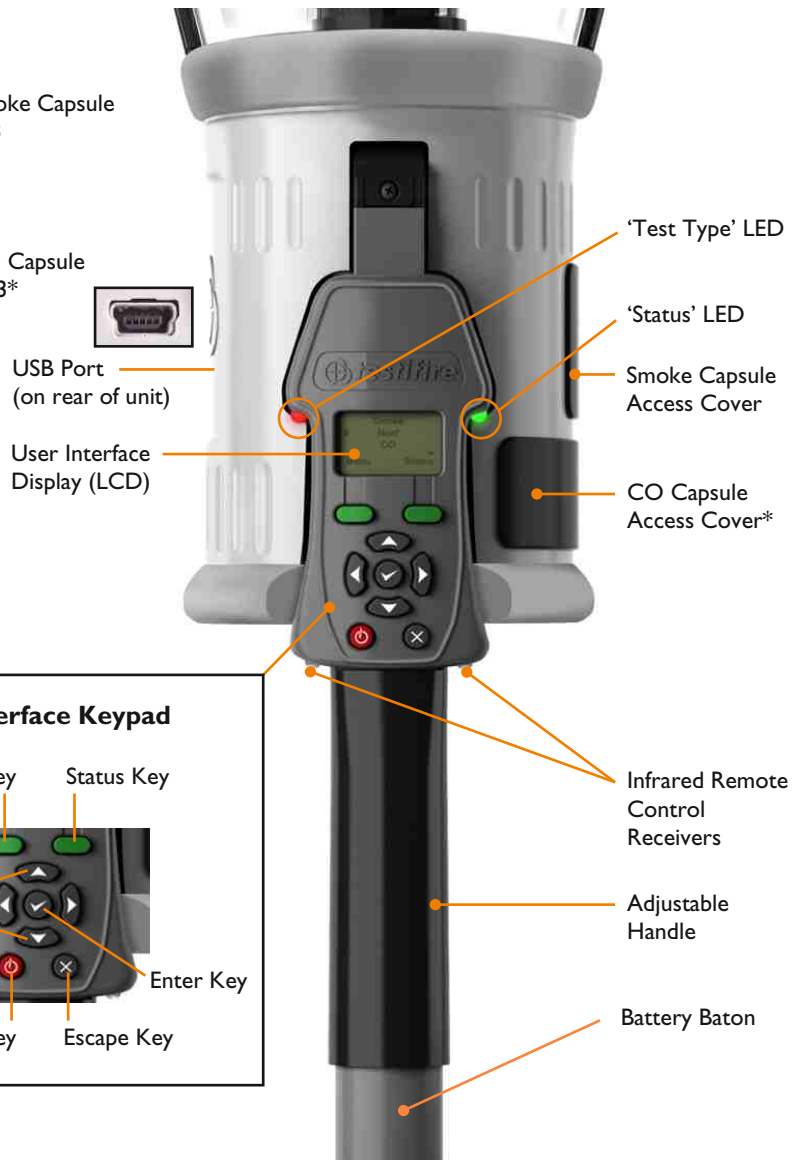
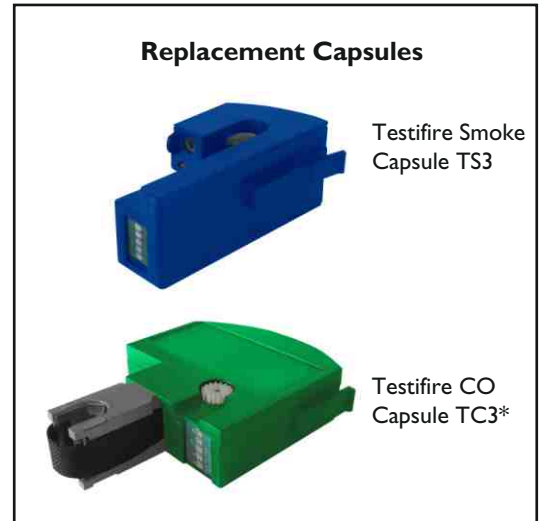
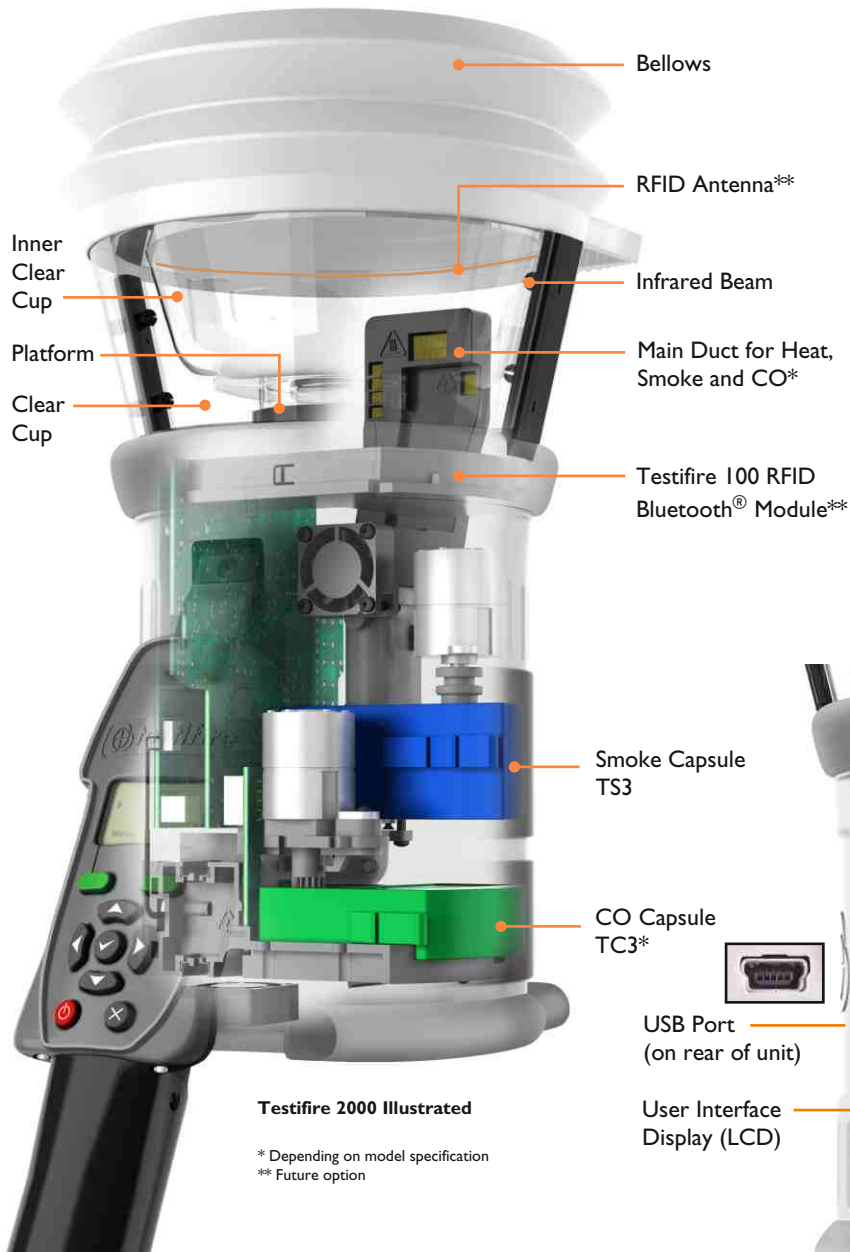

## 4. Preparation For Use

### 4.1 Charging the Battery



#### WARNING

Do not attempt to use or charge the battery if either the unit or the battery connection point are damaged.

Never connect AC and DC power at the same time.

- Solo NiMH Battery Batons are used to power Testifire and enable it to be fitted to Solo Access Poles.
- The Solo760 Battery Baton must be charged before using Testifire. To obtain maximum duration of testing, it should be fully charged for each use. The Solo726 charger should be used for charging Solo760 Battery Batons (Fig. 1).

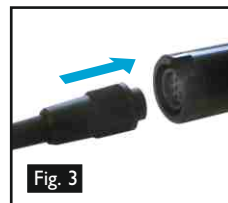

- Connect charger to power outlet / vehicle accessory socket using power cable supplied / umbilical DC connecting lead respectively. LED will not illuminate permanently (Fig. 4).
- Connect the Battery Baton to the charger via the seven pin polarised connector and turn the locking ring (Fig. 2 & 3).
- LED will flash red/green initially, then illuminate red only to indicate fast charging. LED illuminates green only when battery fully charged.
- Charging times will depend on the discharge state of the Battery Baton. Charge times can be 75-90 minutes when charging a fully discharged Battery Baton.
- If LED flashes red, there is a battery fault.

**NOTE:** If Battery Baton is not to be used for some time (i.e. within the next day), it is advisable to unplug the charger from the power supply.

- As with all rechargeable batteries, after a few hundred cycles of normal use your Battery Baton will eventually reach the end of its useable life and will hold less charge or not charge properly. At this point it is recommended that replacement Battery Batons are purchased.
- To ensure the longest possible battery life, discharge the Battery Baton fully before charging whenever possible and avoid leaving the Battery Baton in a discharged state for long periods of time.



### CAUTION

Store charger in a dry place (indoor use only when connected to AC mains). Danger of fire and electric shock! Do not fast-charge a hot battery, allow the Battery Baton to cool down naturally before starting a charge cycle. Allow the charger to cool down for at least 15 minutes after one fast charge. Stop charging if the Battery Baton becomes too hot during charging (>55-60°C). Do not leave unattended whilst charging. Only clean with a dry cloth. Do not attempt to open the charger. Repair permitted only by authorised dealer.

Battery Batons must be stored and charged in accordance with stated environmental conditions.

Environment: Operating temperature: 5°C to 45°C / 40°F to 115°F  
Storage temperature: -10°C to 50°C / 15°F to 120°F  
Humidity: 0-90% RH non-condensing

### ATTENTION

This charger is designed for charging fast rechargeable NiMH Battery Batons (Solo 760) only. Do not connect other types of batteries. Danger of explosion.

### ENVIRONMENT

Battery Batons must be disposed of at a recognised recycling centre. Local authorities can provide advice on the best method.

## 4.2 Using the Battery



### CAUTION

Ensure correct orientation when inserting Battery Baton into tool and do not use undue force to insert.

Remove Battery Baton from Testifire when not in use.

- To insert the Battery Baton into Testifire, hold the Testifire head unit by the handle and depress the upper spring button on the Battery Baton. Align the button with the location hole in the handle and push the Battery Baton into the handle until the button springs up through the location hole (Fig. 5).

**TIP:** Slight rotation of the Battery Baton may assist alignment when inserting.

- Insert the other end of the Battery Baton into the Solo access pole and depress the lower spring button. Align it with the location hole and push the Battery Baton further into the pole until the button springs up through the hole (Fig. 6).





Fig. 5



Fig. 6

### 4.3 Removal and Replacement of the Smoke and Carbon Monoxide (CO) Capsules

	<p><b>CAUTION</b></p> <p>This symbol on the product indicates that this part of the device is susceptible to static damage.</p> <p><b>DO NOT TOUCH</b> the contacts on the PCB on the capsule. Static electricity may damage them and contamination of the contacts must be avoided.</p>
	<p><b>CAUTION</b></p> <p><b>DO NOT TOUCH</b> the black carbon tape of the CO capsule or surrounding area. The tip and surrounding area may be hot after use.</p>
	<p><b>CAUTION</b></p> <p><b>DO NOT</b> insert fingers or other objects into the aperture from where the CO capsule has been removed. There are very hot surfaces which may burn or become damaged if touched.</p>

Smoke and CO capsules are non-refillable. Only replace with genuine Testifire TS3 (Smoke) and TC3 (CO) Capsules.

**Note:** Manufacturer's warranty is conditional on the use of only genuine Testifire replacement parts which must be replaced in accordance with the instructions supplied.

Please observe the local regulations regarding the disposal of packaging materials, exhausted batteries and old electronic equipment.

Empty capsules may be returned to the manufacturer for environmentally-friendly disposal via the reseller to comply with WEEE (Waste Electrical & Electronic Equipment) Regulations 2006.

Only use gentle pressure when inserting the capsules.

#### Smoke Capsule Removal Instructions (Testifire 1000 and 2000 series)

- Release the upper access cover **A** (Fig. 7) on the body of the Testifire unit by opening it from the right hand side. **Note:** Testifire 1000 series units only have one access cover.
- Squeeze the two clips **B** (Fig. 7) on each side of the used capsule and gently pull the capsule out.

#### Smoke Capsule Replacement Instructions

- Remove the capsule from its outer carton and anti-static bag.
- Remove the spring clip protector cap **C** (Fig. 8) from the new capsule.
- Holding the capsule by the spring clips **B** (Fig. 8) with the label on the underside, carefully insert the new capsule into the capsule port. Push it into position, ensuring that the clips spring out positively on both sides of the capsule to engage correctly with the port.
- Close the Smoke access cover **A** (Fig. 7) securely.

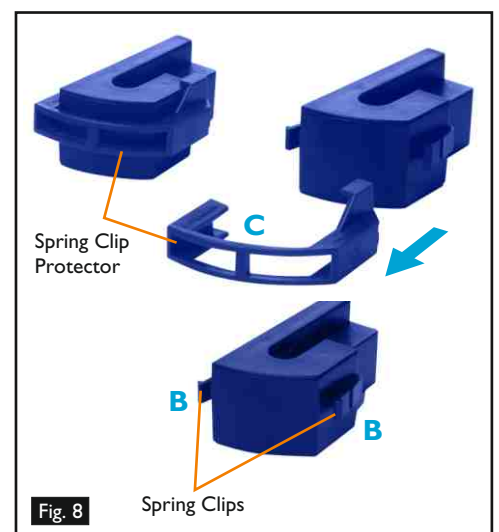
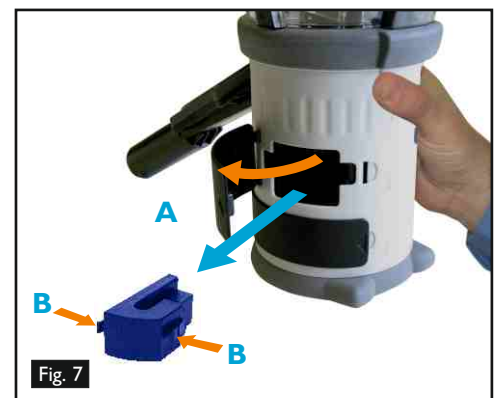

## CO Capsule Removal Instructions (Testifire 2000 series only)

- Only replace the CO capsule when it is empty. Testifire should be turned off for five minutes to allow the 'CO' capsule to cool down before removing it.
- Release the lower access cover **D** (Fig. 9) on the body of the Testifire unit by opening it from the right hand side.
- Squeeze the spring clips **E** (Fig. 9) on each side and gently pull the capsule out.
- Do not touch the tip of the CO capsule as it may be hot.

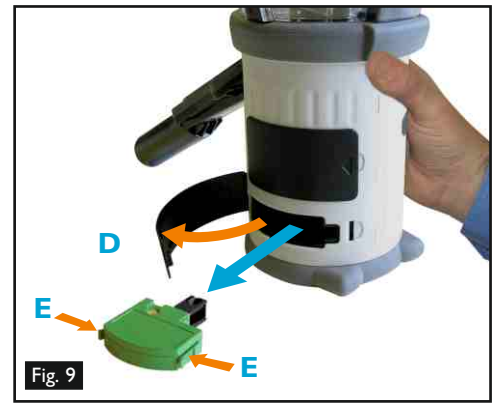





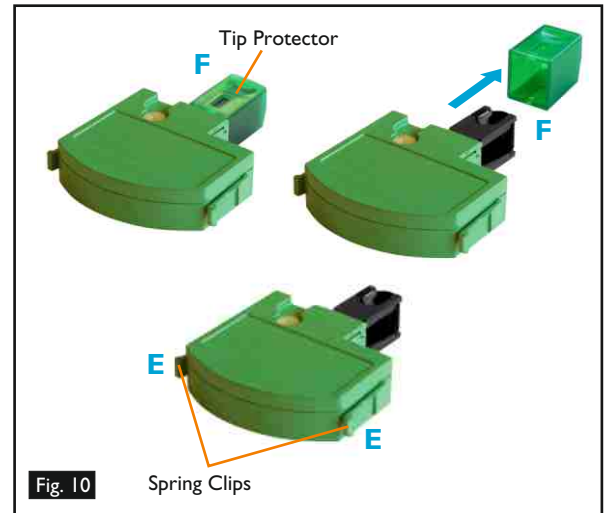

## CO Capsule Replacement Instructions

- Remove the capsule from its outer carton and anti-static bag.
- Remove the tip protector from the tip of the capsule **F** (Fig. 10).
- Holding the capsule by the spring clips **E** (Fig. 10) with the label uppermost, carefully insert the new capsule into the capsule port. Push it into position, ensuring that the spring clips spring out positively on both sides of the capsule and engage with the port properly. Close the CO access cover **D** (Fig. 9) securely.







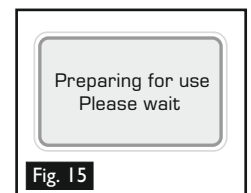
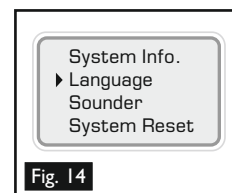
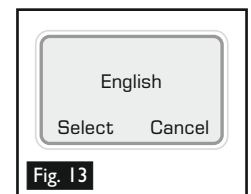



## 4.4 Turning the Unit On

- To turn the unit on, press and hold the red 'ON-OFF' key  for 2 seconds (Fig. 11). The 'Status' LED will flash slowly green to indicate that the unit is in 'STANDBY' mode.
- The first time the unit is powered-on (or after a 'System Reset' see Section 6.2), you will be prompted to select the Testifire operating language for your region. Use the 'UP' and 'DOWN' keys  to navigate and 'ENTER' key  to select your required operating language (Fig. 12).
- This will display a confirmation screen (Fig. 13). Press the 'MENU' key to select or the 'STATUS' key to cancel. Once the language has been selected the 'MAIN' menu will be displayed.
- The chosen language can be changed at any time by pressing the 'MENU' key. Use the 'UP' and 'DOWN' keys  to navigate the menu and use the 'ENTER' key  to select 'Language' (Fig. 14). Pressing the 'ESCAPE' key  goes back to the 'STANDBY' screen.
- After long periods of non-use or when a Smoke Capsule has been replaced, the unit will self-prime at power-on, prior to displaying the 'MAIN' menu. Testifire will show the 'Preparing for use Please wait' message for a short period while it is priming the circuits ready for use (Fig. 15).





- If the unit is left in Standby mode for more than 5 minutes, it will power off to conserve the battery.

## 4.5 Using the Menus

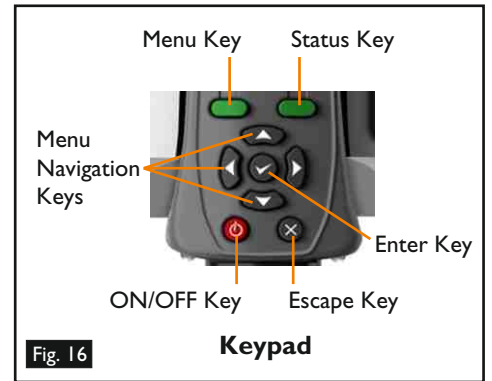
- Before turning Testifire on for the first time, it is recommended that you become familiar with system menus.
- Testifire's menu system is simple to navigate. Using the 'UP' and 'DOWN' menu navigation keys , you can move the cursor through the 'MAIN' menu (Fig. 16). Press the 'ENTER' key  to select stimuli from the 'MAIN' menu or to display sub menus.
- Pressing the 'ESCAPE' key  goes back to the 'MAIN' menu or, when a test sequence has been programmed and the 'MAIN' menu is displayed, the 'ESCAPE' key  will cancel the programmed test sequence.
- A 'DOWN' arrow  on the bottom right of the 'MAIN' menu indicates options are available below. Use the 'DOWN' key  on the keypad to move down through the menu. (Fig. 17).
- The 'UP' arrow  on the 'MAIN' menu indicates options available above. Use the 'UP' key  on the keypad to move up through the menu (Fig 18).
- Press the 'LEFT' key  on the keypad to go back one menu level.



**TIP:** For a single test, use the 'UP' and 'DOWN' keys  to highlight 'Smoke', 'Heat' or 'CO' as required on the 'MAIN' menu. You do not need to press the 'ENTER' key  on the keypad to select, just leave the required test stimuli highlighted (Fig. 19).

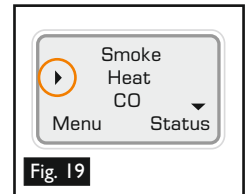
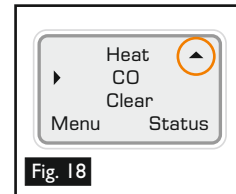
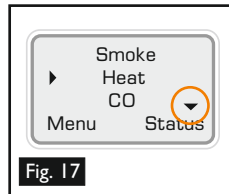

## 4.6 Adjusting the Head Unit Angle

- Correct head angle adjustment is important to make sure that the detector to be tested is correctly positioned in the inner clear cup and the user is in a safe and appropriate position to carry out the test. The detector should touch the base of the Testifire inner clear cup and should be level with the base of the detector (Fig. 20).
- Adjust the head unit for the correct angle to access the detector to be tested. Hold the body of Testifire and, pulling gently against the spring, angle the head unit away from the Battery Baton (Fig. 21). The head unit will be free to rotate to the desired position and, on release, it will lock and remain locked for use (Fig. 22).





## 4.7 Testing High Profile Detectors



- When testing high profile detectors, it may be necessary to remove the inner clear cup to enable the detector to sit in the correct position for a successful test. The inner clear cup has a semi-circular cut-out on the side nearest to the user interface. Place your finger in the cut-out and carefully lift out the cup (Fig. 23). This will allow for correct positioning of the high profile detector within the cup (Fig. 24).



**TIP:** To prevent Testifire going straight into a test mode, both the inner and outer clear cups should be cleaned regularly with a damp non-abrasive cloth to remove any deposits or finger marks.

## 5. Using Your Testifire

	<p><b>CAUTION</b></p> <p>This product is intended to be used at height.</p> <p>Exercise great care and always wear appropriate PPE (personal protective equipment) when operating above head height in order to avoid the risk of injury.</p> <p><b>DO NOT OVER REACH.</b> Keep proper footing and balance at all times. Proper footing and balance enables better control of the equipment in unexpected situations.</p> <p>Care should always be taken when using Testifire at height. Pay particular attention to avoid contact with overhead items such as light fittings, overhead power cables/busbars and any other objects that could be accidentally dislodged which might cause danger to the operator or anyone else in the vicinity.</p>
	<p><b>CAUTION</b></p> <p>This product contains hot surfaces and hot air is also emitted from the duct outlet.</p> <p><b>DO NOT TOUCH</b> the tip of the CO capsule when it has been removed if the unit has been in operation within the previous 5 minutes. It will be very hot immediately after use and may burn if touched.</p> <p><b>DO NOT</b> insert fingers into the aperture from where the CO capsule has been removed. There are very hot surfaces which may burn if touched.</p> <p>Avoid placing hands near the duct outlet during heat testing or within 5 minutes of conducting heat testing. Hot air is emitted from the duct and the top of the duct will get hot to the touch.</p>
	<p><b>WARNING</b></p> <p>This product emits small amounts of carbon monoxide (CO) gas which is a harmful, odourless gas.</p> <p><b>DO NOT INHALE</b> directly from the duct during a CO test or within 5 minutes of conducting a CO test.</p> <p>Note: Under normal operating conditions, this emission will present no harm to the user. For additional information please refer to the separate safety information provided.</p>

- After you have completed the preparation procedures, Testifire will be ready for use.
- To carry out a simple, single stimulus test, use the 'UP' and 'DOWN' keys  on the keypad (as described in section 4.4 of this manual) to highlight the stimulus required (Fig. 25). Although you can select the required stimulus by pressing the 'ENTER' key , all that is required for a single stimulus test is to highlight the required stimulus (complex sequences of single-stimulus tests, or a simultaneous multi-stimulus test are covered in Sections 5.8, 5.9 and 5.10).

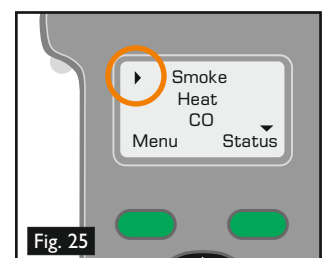



- Once the stimulus has been selected, the 'Test Type' LED will change colour to indicate the following:

● Red = Heat Test   
 ● Blue = Smoke Test   
 ● Green = Carbon Monoxide Test   
 ● Clear = Clearing

- The 'Status' LED provides feedback on the modes of operation and alerts you to errors or when a smoke or CO capsule is empty or incorrectly fitted. The Indicating LED Reference Chart details all of the variations (see Section 5.13).



## 5.1 Sounder Option

- Two different 'beeps' are emitted from Testifire. A short 'beep' when pressing the 'Power-On' button and for a key press ('Keypad'), and a longer 2-second 'beep' for errors ('Warning').
- In some environments the sound may not be desirable. Testifire has an option that allows both types of 'beep' to be disabled. Once disabled, the sound stays disabled until it is manually enabled again or a 'SYSTEM RESET' takes place. (see Section 6.2).
- To disable the sound, press the 'MENU' key and using the 'UP' and 'DOWN' keys on the keypad, navigate to 'Sounder' (Fig. 26) and select using the 'ENTER' key . Use the 'ENTER' key also to select 'ON' or 'OFF' for the 'Keypad' and 'Warning' sounds (Fig. 27).

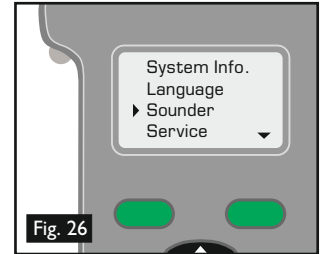

Fig. 26

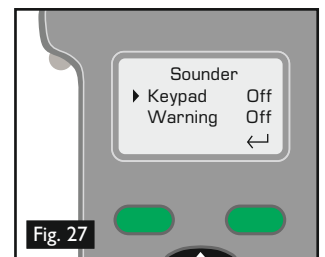

Fig. 27

## 5.2 Testing a Detector

- Raise Testifire up to the detector to be tested and place it centrally over the detector. As the detector enters the clear cup and interrupts the built-in infrared sensor in the head of Testifire, the selected tests or sequence of tests, begin.

**NOTE:** It is very important that the detector under test is in the correct position within the clear cup for a successful test to take place. The detector should sit on the platform and the top of the inner clear cup should be parallel to the detector base. Ideally, the bellows should seal against the ceiling surface (Fig 28).



Fig. 28

- When testing high profile detectors, it may be necessary to remove the inner clear cup to enable the detector to sit in the correct position for a successful test. The inner clear cup has a semi-circular cut-out on the side nearest to the user interface. Place your finger in the cut-out and carefully lift out the inner clear cup (Fig. 29).

**TIP:** Ideally, the detector LED should be visible through the inner cup of the head unit. In some instances this is not possible. To improve visibility of the detector LED, lower Testifire briefly, (2 seconds maximum), raising it again to continue the test.



Fig. 29

- For single-stimulus tests, the 'Test Type' LED will remain illuminated in one colour only, and for a sequence of single-stimulus tests it will show the colour relating to the current test. For a multi-stimulus simultaneous test, it will show all the colours relating to the stimuli in the test, alternating its colour repeatedly between them.
- If after 2 minutes the test has not completed, Testifire will time out.
- When the detector is activated, remove Testifire by lowering it gently. Testifire will return to 'STANDBY' mode as the Infrared beam is re-established and the 'Status' LED will flash slowly again.

**Testifire may be used in a variety of modes for detector testing. Multiple stimuli (Smoke, Heat, CO) may be tested either simultaneously (all at once) and/or sequentially (in various combinations). The stimuli and their method of operation are described in the following sections.**

**NOTE:** Lowering Testifire during a test will do the following:

- For less than 2 seconds:** Nothing. The test will continue as soon as the detector re-enters the cup.
- For more than 2 seconds:** During a Sequential Test, Testifire will advance to the next test that is programmed.
- For more than 10 seconds:** During a Sequential or Simultaneous Test, Testifire will reset and return to the first test of the programmed test sequence.

### 5.3 Smoke Testing

- To select a smoke test on the 'MAIN' menu, move the cursor to 'Smoke' using the 'UP' and 'DOWN' keys  on the keypad (Fig. 30). The test will begin automatically when the head unit is placed over the detector and the infrared beam is broken.
- The 'Test Type' LED on Testifire will confirm that smoke is being generated by illuminating blue.
- Smoke is generated and blown into the detector within a few seconds of the test beginning.
- Not all of the smoke is visible to the naked eye and it must not be assumed that there is a problem when smoke is not immediately seen emerging from the unit.
- The amount of smoke produced may vary throughout the test.
- During a smoke test, a slight 'popping' noise may be heard during the smoke generation. This is normal and part of the test procedure.

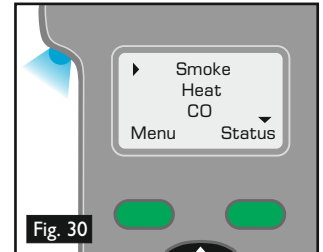



### 5.4 Heat Testing

	<p><b>CAUTION</b></p> <p>Avoid placing hands near the duct outlet during heat testing or within 5 minutes of conducting heat testing.</p> <p>Hot air is emitted from the duct and the top of the duct will get hot to the touch.</p>
---	--

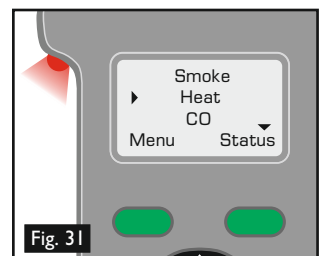
- To select a heat test on the 'MAIN' menu, move the cursor to 'Heat' using the 'UP' and 'DOWN' keys  on the keypad (Fig. 31). The test will begin automatically when the head unit is placed over the detector and the infrared beam is broken.
- The 'Test Type' LED on Testifire will confirm that heat is being generated by illuminating red.
- Heat is blown from the duct immediately the test begins. The temperature of the air emerging from the duct is such that it can heat the thermal sensor in the detector.
- The heat is produced in a narrow stream and is not intended to heat up the whole inner clear cup area of Testifire. Instead, only the area immediately around the thermal sensor in the detector will be heated in order to preserve battery power.



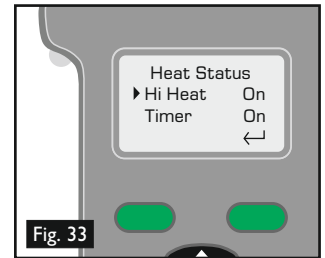

- A 'Hi Heat' setting for fixed temperature detectors which operate at more than 90°C (194°F) is available. It is recommended that for most tests the 'Heat' (normal heat) setting is used as this will conserve battery power.
- To select a 'Hi Heat' test, use the 'UP' and 'DOWN' keys  on the keypad to highlight 'Heat'. Press the 'STATUS' key on the keypad (Fig 32), and then move the cursor to 'Hi Heat' (Fig 33) using the 'UP' and 'DOWN' keys  on the keypad. Press the 'ENTER'  key to select 'Hi-Heat'.
- After selecting 'Hi Heat', Testifire will revert to the 'Heat' setting when the unit is switched off and on again.



### Special Notes for Heat Detectors

- Heat detectors have a thermal sensor (normally a thermistor) that detects heat. This is usually mounted centrally within the detector which allows for easy alignment of Testifire. For heat detectors with either dual or offset thermistors, the main duct of the Testifire head unit should be aligned with the thermal sensor. Incorrect alignment could result in a failed test.
- If after 2 minutes the test has not completed, Testifire will timeout. When Testifire is lowered (re-establishing the Infrared beam) it will switch to 'STANDBY' mode, ready to carry out the next test. The 'Status' LED will flash slowly alternating between green and red for 3 seconds before reverting to slowly flashing green indicating 'STANDBY' mode. For tests started with the Infrared Remote Control, Testifire's timeout mode is different. The red-green flashing led timeout mode will only last for 10 seconds after which the test sequence will be cancelled and the unit will revert back to standby mode.
- When using the 'Heat' setting, care should also be taken not to leave the Testifire head unit in position over a detector for too long. The plastics used in some detectors with thermal sensing elements that respond to rate-of-rise, or reasonably low absolute temperatures, may soften if exposed to heat for long periods of time.
- Extra care should be taken not to overheat a detector when using the 'Heat' setting combined with 'Smoke' and/or 'CO' (two or more at the same time) as there may be a delay in response from the slowest sensor. This may mean that the heat has been applied for longer than necessary for the element of the detector to activate.

### NFPA 72 - Heat Detector Testing

- To enable compliance with NFPA 72, a 60 second heat timer option is available. Selecting this option stops the heat test at 60 seconds as required by the standard. A 'Timer' option is available for 'Heat' and 'Hi-Heat' settings.
- To select the 'Timer' option, highlight 'Heat' or 'Hi Heat' on the 'MAIN' menu. Press the 'STATUS' key (Fig 34), and move the cursor by using the 'UP' and 'DOWN' keys  on the keypad to highlight 'Timer' on the menu (Fig 35). Press the 'ENTER' key  on the keypad to select. A countdown icon will appear on the 'MAIN' menu alongside 'Heat' or 'Hi Heat' (Fig 36).
- Once the Timer option has been selected it will stay on until it is turned off manually or a 'SYSTEM RESET' takes place (see Section 6.2).

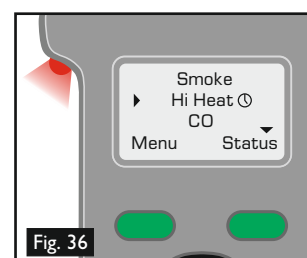
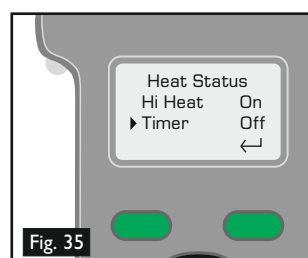

## 5.5 Carbon Monoxide (CO) Testing



### WARNING

This product emits small amounts of carbon monoxide (CO) gas which is a harmful, odourless gas.

**DO NOT INHALE** directly from the duct during a CO test or within 5 minutes of conducting a CO test.

Note: Under normal operating conditions, this emission will present no harm to the user. For additional information please refer to the separate safety information provided.

- To select a CO test on the 'MAIN' menu, move the cursor to 'CO' using the 'UP' and 'DOWN' keys  on the keypad (Fig. 37). The test will begin automatically when the head unit is placed over the detector and the infrared beam is broken.
- CO is invisible and it will not be apparent that the gas is present during a test. The 'Test Type' LED on Testifire will confirm that CO is being generated by illuminating green.
- CO is generated and gently blown into the detector.
- When used as directed, Testifire is safe for testing CO Fire Detectors. It is not suitable for testing most Life Safety CO Detectors which typically require exposure to far higher level of carbon monoxide to activate.
- After carrying out a CO test (singularly or as part of a programme). Testifire cools the CO heater element. The right hand 'Status' LED will flash Green and Red with longer gaps between the flashes. Once the CO heater element temperature has been reduced, the 'Status' LED will indicate 'STANDBY' mode, by flashing Green slowly. The next CO test can then be carried out.

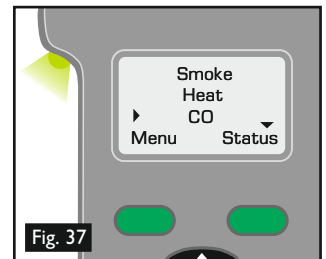

## 5.6 Clearing the Detector

- This operation blows air into the detector to clear it of smoke. It does not clean the internal components of the detector.
- To select the clearing function on the main menu, move the cursor to 'Clear' using the 'UP' and 'DOWN' keys  on the keypad (Fig. 38). The clearing operation will begin automatically when the head unit is placed over the detector and the infrared beam is broken. The 'Status' LED will flash fast in green or fast in red if the battery is low.
- The 'Test Type' LED will not be illuminated at all during a clearing operation.

**TIP:** Set 'Clear' as part of a sequential test with 'Smoke' e.g. 'Smoke' is 1 and 'Clear' is set to 2 (Fig. 39). This will speed up the testing of smoke detectors as the clearing process will remove the possibility of the detector reactivating. See Section 5.9 for details of how to set up a sequential test.

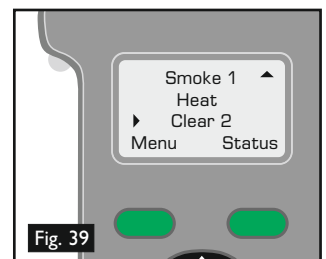
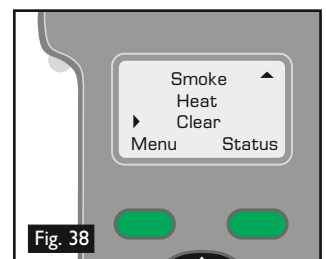

## 5.7 Capsule Fuel Level



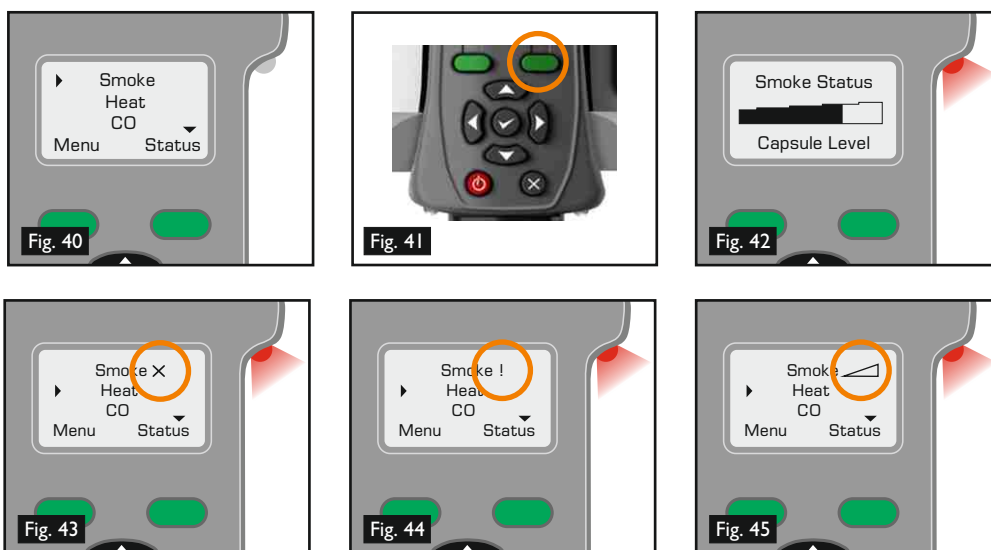

- The remaining level of 'Smoke' and 'CO' fuel available in the capsules can be displayed on the screen by highlighting 'Smoke' or 'CO' in the 'MAIN' menu by using the 'UP' and 'DOWN' keys  on the keypad (Fig. 40) and then pressing the 'STATUS' key (Fig. 41) to display the capsule level (Fig. 42).
- Attempting to carry out a test with an empty capsule will result in an error. The 'Status' LED will illuminate red and 'Capsule Empty' will be displayed on the screen.
- If an 'X' is displayed beside 'Smoke' or 'CO' on the 'MAIN' menu it indicates that there is a problem with the capsule (Fig. 43). Either it is not installed, or it is installed incorrectly.
- If an '!' is displayed beside 'Smoke' or 'CO' it indicates that the capsule is nearly empty (Fig. 44). Make sure you have replacements available.
- If an '▲' is displayed beside 'Smoke' or 'CO' it indicates that the capsule is empty (Fig. 45) and requires replacement.



## 5.8 Simultaneous Testing

Using Testifire to carry out a Simultaneous Test means that a number of operations (Smoke, Heat and CO) can be pre-programmed into the unit before it is raised up to the detector. This saves time, reduces handling and enables the testing of certain multi-sensor detectors if they are so enabled.

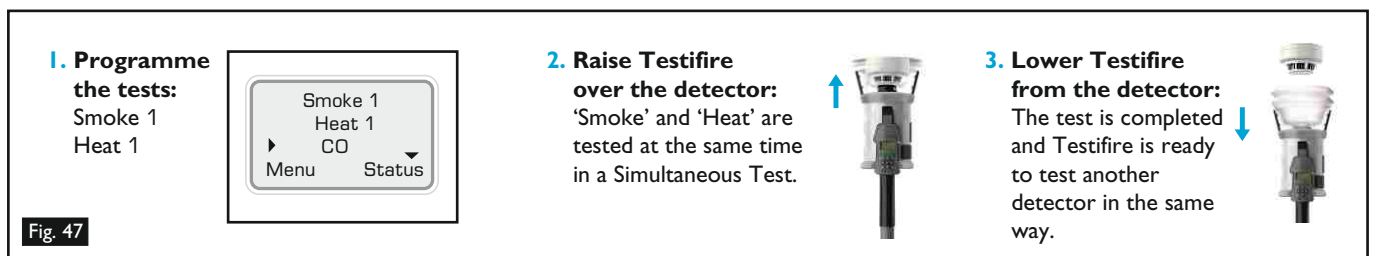
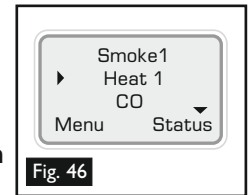

**Note:** Depending on the detection system being tested, there may be no individual indication of the activation of the separate sensors in the detector. The system may activate on one sensor only.

- A stimulus for a Simultaneous Test is programmed by moving the cursor to the desired test using the 'UP' and 'DOWN' keys  on the keypad, and then pressing the 'ENTER' key  to select that test (Fig. 46). It will appear with a number designation beside it on the LCD. After the first one (which will be designated '1') choose the second stimulus in the same manner and then press the 'ENTER' key  a second time and its number designation will also change to '1'. Add the third stimulus in the same way if required, ensuring that the 'ENTER' key  is pressed again until it displays '1' adjacent to that stimulus. When complete, all the required stimuli should have the designation '1' next to them. The 'Test Type' LED will show alternating colours according to the stimuli chosen (for details of these colours, see Section 5.13 of this manual). Fig. 47 illustrates the procedure for a Simultaneous Test (in this example for 'Smoke' and 'Heat' at the same time).
- To delete a simultaneous test setup, use the 'ESCAPE' key .



## 5.9 Sequential Testing

Using Testifire to carry out a Sequential Test means that a number of operations (Smoke, Heat, CO and Clearing) can be pre-programmed into the unit before it is raised up to the detector. This saves time, reduces handling and enables the testing of certain multi-sensor detectors if they are so enabled.

- Any or all of the above test modes (Smoke, Heat, CO, Clearing or a Simultaneous Combination) can be programmed into a short test sequence of up to four elements.
- Sequences are programmed by moving the cursor to the desired test using the 'UP' and 'DOWN' keys  on the keypad, and then pressing the 'ENTER' key  to select that test (Fig 48). The first stimulus added in this way will appear with the number '1' designation beside it on the LCD. Then, the next test stimulus in the sequence is chosen in the same way, and it will show '2' beside it, and so on if required.
- To cycle between the different tests in a Sequential Test, Testifire needs to be lowered slightly for at least 2 seconds, but not more than 10 seconds (re-establishing the infrared beam) so that it can advance to the next test (see Fig. 47[3]). Example: For testing 'Smoke' followed by 'Heat' and then 'CO', Testifire is raised over the detector, the detector interrupts the infrared beam and the 'Smoke' test begins. The test is successful (or fails after Testifire times out). Lower the head unit for 2 seconds so that the detector is clear of the clear cup and bellows, and then raise it again to start the 'Heat' test. Repeat this procedure for the 'CO' test.
- During a Sequential Test, the detector needs to be removed from the cup for more than 2 seconds to enable Testifire to advance to the next test in the programmed sequence. If the detector does not re-enter the cup within 10 seconds, the test sequence will reset and return to the first test of the programmed sequence.

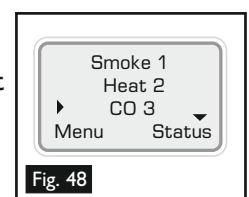

- Another identical test sequence will automatically be ready to begin at this point, and there is no need to re-select the test on the keypad. Fig. 49 illustrates the procedure for a Sequential Test (in this example for 'Smoke' followed by 'Heat' and then 'CO').

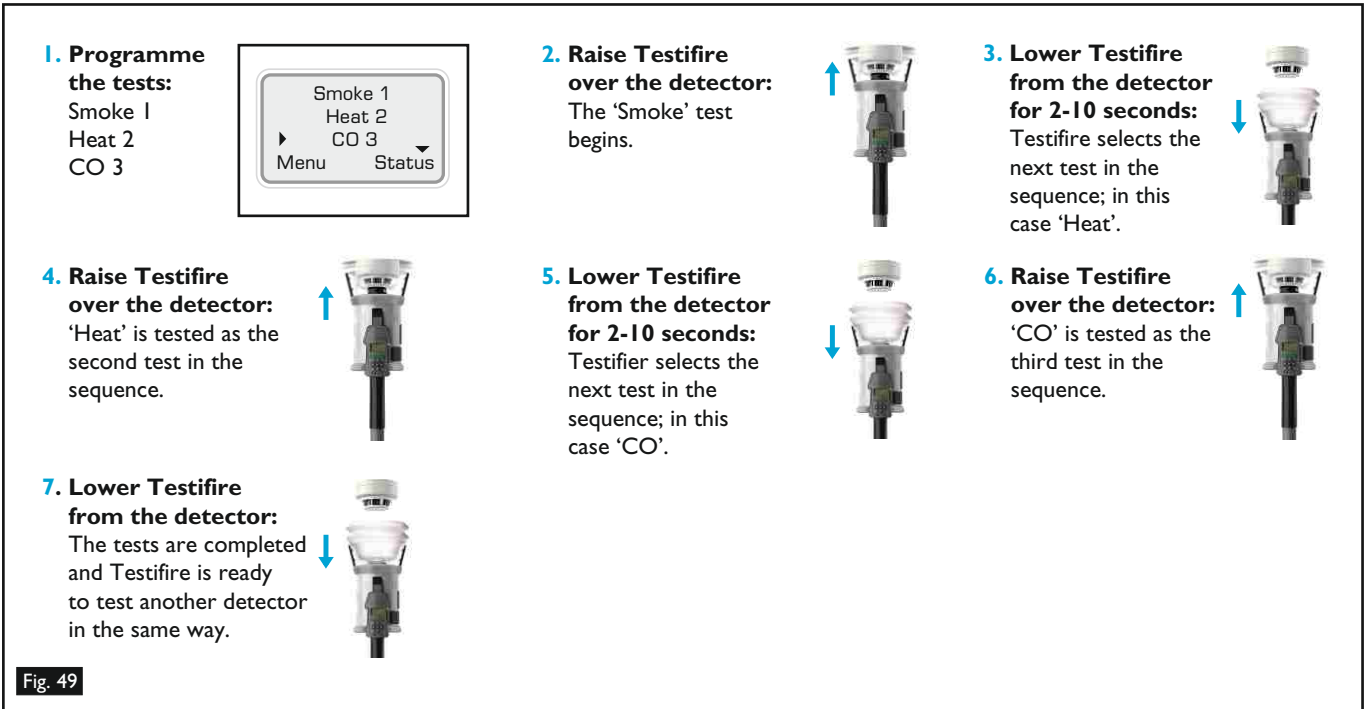

- To delete a test sequence, use the 'ESCAPE' key .

## 5.10 Combined Simultaneous and Sequential Testing

If required, a combination of Simultaneous and Sequential Testing is possible with Testifire. Using the above methods it is possible to programme a number of combinations into the unit. In the example below, 'Heat' and 'Smoke' are combined as the first operation, followed by a 'CO' test. (Note: you will still need to lower the head unit for 2 seconds after the 'Smoke' and 'Heat' test is completed and raise it again to initiate the 'CO' test). Fig. 50 illustrates the procedure for a Combined Simultaneous and Sequential Test (in this example for 'Smoke' and 'Heat' at the same time followed by a 'CO').

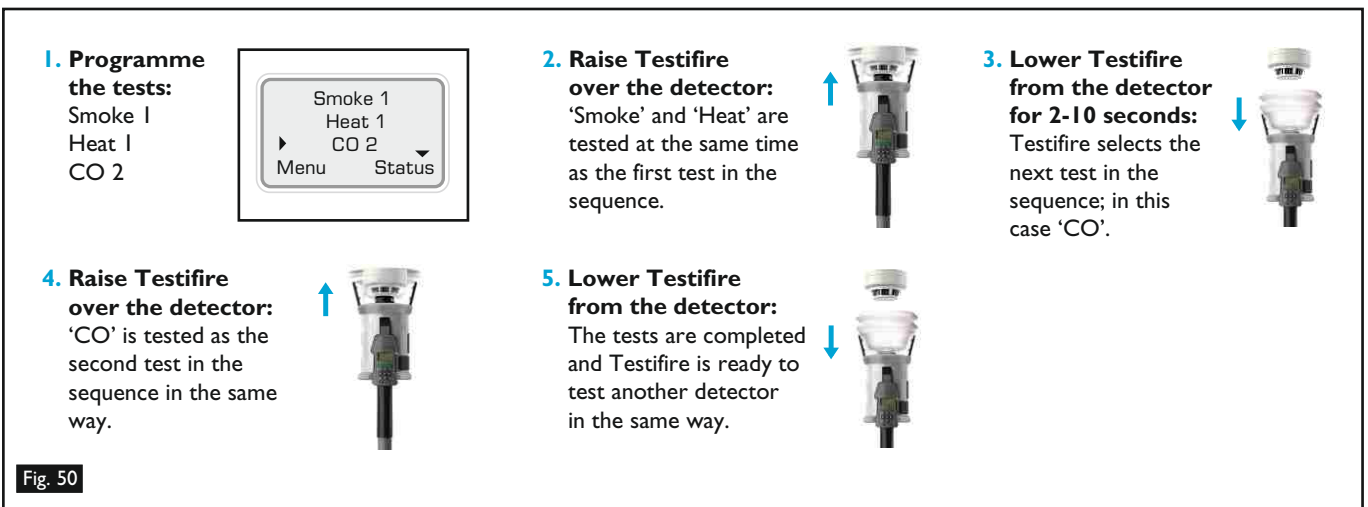

### 5.11 Infrared Remote Control (Testifire 25)

Some types of detector may not automatically initiate a test as they enter the clear cup of Testifire. The Infrared Remote Control can be used to manually start a test, and/or move on to the next test in the sequence. Aim the infrared beam LED at the Testifire head unit when it is at height and use the operation button on the Infrared Control Unit to start/stop a test.

The Infrared Control Unit is powered by two AAA batteries which can be replaced by opening the panel located on the back of the unit.



### 5.12 RFID Auto Tests (Testifire 100)

A Testifire 100 communication module (which includes RFID and Bluetooth®) will be available as a future option.

Amongst other reporting functions, a detector can be identified via an RFID tag which may be fixed to the back of the fire detector. This enables communication between Testifire and the tag and thereby allows Testifire to identify the detector and perform the correct test/s automatically without programming.

Using an open protocol Bluetooth® link, Testifire also offers the ability to communicate with any supporting third party software application. This allows data to be exchanged between the RFID tag (label) and a PDA including, for example, the identity of test personnel, the maintenance company, time and date of test and test results. To be able to use this feature, each detector must be fitted with a Testifire compatible RFID tag and the type of test that is required to be performed automatically will need to be programmed into the tag.

Once the Testifire communication module is available details will be available from our website: [www.testifire.com](http://www.testifire.com).

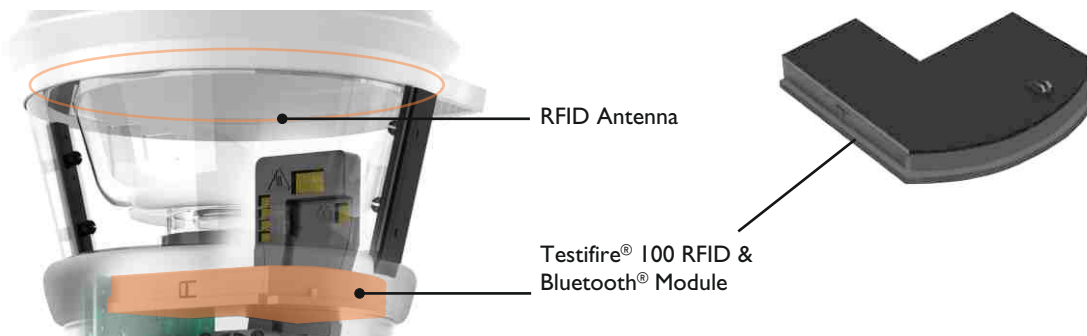



## 5.13 Indicating LED Reference Chart

### 'Test Type' LED

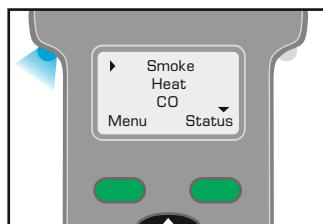

**Blue Solid**  
Smoke Test in progress

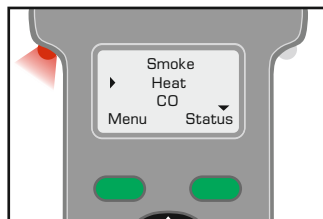

**Red Solid**  
Heat Test in progress

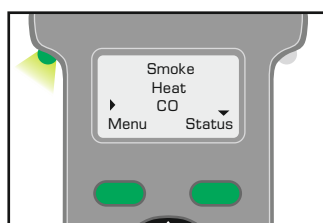

**Green Solid**  
CO Test in progress

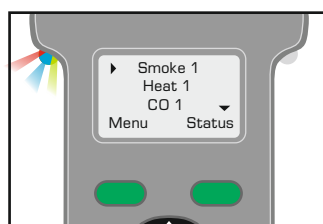

**Red/Blue/Green Alternating**  
Smoke, Heat & CO test in progress at the same time (Simultaneous Testing)

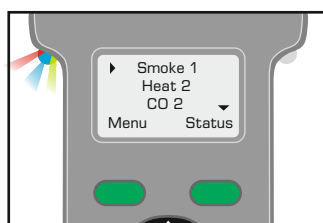

**Blue Solid/ then Red/Green Alternating**  
'Test in progress' portion of Smoke, then Heat & CO combined testing (Sequential Testing)

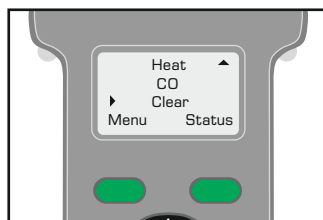

**Not Illuminated**  
Clearing mode in operation

### 'Status' LED



**Green Slow Flashing**  
'STANDBY' Mode



**Green Fast Flashing**  
'OPERATIONAL' Mode (test in progress)



**Red Flashing**  
(slow red flashing in 'STANDBY' mode or fast red flashing in operation)  
  
Battery needs charging - Testfire still operational (see Section 4.1)

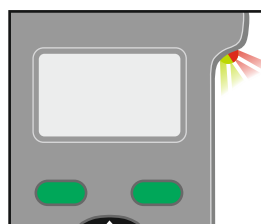

**Alternating Red/Green Flashing**  
'TIME OUT' Indication (after 2 minutes of continuous testing on one stimulus or combination of stimuli)

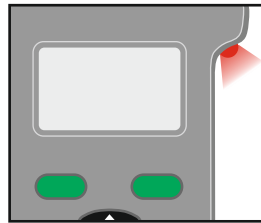

**Red Solid**  
Error - see message on display (see Section 6.1)



**Alternating Green flashes**  
"CO Cooling phase" - Indication after a CO test has been carried out. Further CO test cannot be carried out until Status LED shows "STANDBY" mode.



## 6. Troubleshooting

If you experience any type of problem with your Testifire, turn the power off, wait for a few seconds and then turn the power back on. This may clear the fault. If the fault continues, the following information may help you solve the problem. If you are unable to identify the cause of the problem, please contact your regional support centre.

### 6.1 Errors

- When an error occurs, the 'Status' LED will remain on in red and the 'Test Type' LED will not be illuminated. This can be clearly seen without access to the LCD screen when the unit is at height.
- The unit will emit a 2 second 'warning beep' (if the 'beep' sound is enabled) and cease to function further. The LCD screen will display the error message (see Section 6.3).
- In some cases the error message may be cleared from the LCD by pressing the 'ESCAPE' key  on the keypad. This may enable the unit to continue operating, although if the error has not been corrected the error message may reappear immediately on the LCD.
- You will need to correct the error in order to proceed. For example, if the battery is Low, the LCD will display the message 'Replace Battery'. In this case, no further testing can be carried out until the Battery Baton has been recharged or replaced.
- A complete listing of the screen error messages and indicating LED colours is detailed in Section 6.3.
- For RFID error messages see the RFID Manual at: [www.testifire.com](http://www.testifire.com).

### 6.2 System Reset

- When you have followed the above steps and you still have a problem, carry out a 'System Reset' to restore your Testifire unit back to the factory defaults. A 'System Reset' will remove all user customisable settings including:
  - Clear all programmed test sequences
  - Turn off the Timer option
  - Turn Warning and Keypad Sound 'beeps' on
  - Revert to 'Heat' if 'Hi-Heat' has been selected
  - Remove the selected language
- To carry out a 'System Reset', press the 'MENU' key on the keypad (Fig. 51) and use the 'UP' and 'DOWN' keys  to navigate to the 'System Reset' (Fig. 52). Press the 'ENTER' key  to select the 'System Reset'. This will display a 'System Reset' confirmation screen (Fig. 53). Select 'Ok' by pressing the 'MENU' key to execute the 'System Reset' or select 'Cancel' by pressing the 'Status' key to cancel a 'System Reset'.

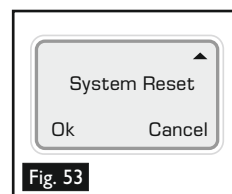
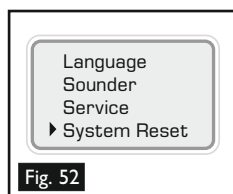
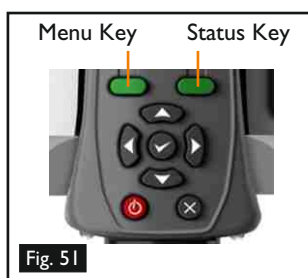

- Following a 'System Reset', the Testifire logo will appear on the start up screen, followed by the 'Select System Language' option (see Section 4.4).

## 6.3 Error Messages and Indicating LED Reference Chart

**Note:** If a problem occurs with your Testifire unit, the 'Status' LED will flash or remain on in red and the 'Test Type' LED will not be illuminated. The error message will be displayed on the screen.

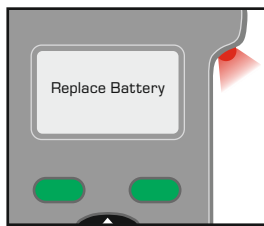

If the 'Status' LED is flashing you need to recharge or replace the Battery Baton soon.  
If the 'Status' LED is solid red, you must recharge or replace the Battery Baton immediately.

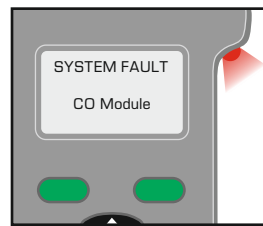

A problem has occurred with the CO Module.  
Contact your regional service centre to arrange for repair of the fault.

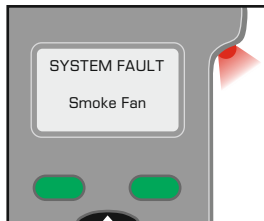

A problem has occurred with the Smoke Fan.  
If the error continues, contact your regional service centre to arrange for repair of the fault.

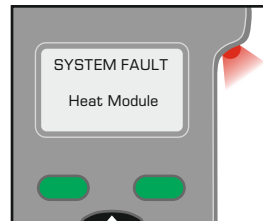

A problem has occurred with the Heat Module.  
Contact your regional service centre to arrange for repair of the fault.

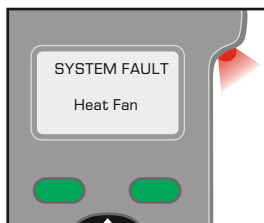

A problem has occurred with the Heat Fan.  
If the error continues, contact your regional service centre to arrange for repair of the fault.

### Capsule Error Messages (Smoke and CO):

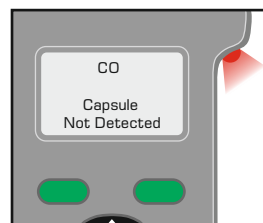

Capsule not installed.  
Reseat capsule (if installed) or install a new capsule.

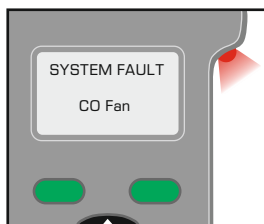

A problem has occurred with the CO Fan.  
If the error continues, contact your regional service centre to arrange for repair of the fault.



Capsule empty.  
Install a new capsule.

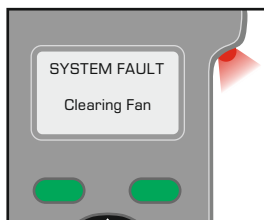

A problem has occurred with the Clearing Fan.  
If the error continues, contact your regional service centre to arrange for repair of the fault.



Capsule damaged or not seated correctly.  
Reseat capsule.  
If the error persists, replace capsule.



A problem has occurred with the Chassis Fan.  
If the error continues, contact your regional service centre to arrange for repair of the fault.

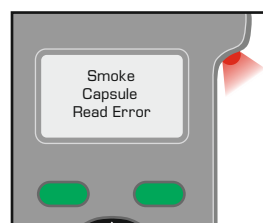

Capsule damaged or not seated correctly.  
Reseat capsule.  
If the error persists, replace capsule.

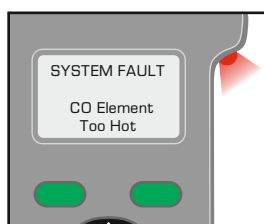

The CO element is too hot.  
Power off and leave too cool for 5 minutes. Power on and try the same test again.  
If the same message is displayed, contact your regional service centre to repair the fault.

## 7. Support

### 7.1 Technical Support

For support, service and further information, please contact:

#### No Climb Products Ltd

Edison House, 163 Dixons Hill Road, Welham Green, Herts, AL9 7JE United Kingdom

Tel: +44 (0) 1707 282760 Fax: +44 (0) 1707 282777

Email: [support@testifire.com](mailto:support@testifire.com)

Online help available at [www.testifire.com](http://www.testifire.com)

### 7.2 Firmware Updates

- All Testifire head units have a built-in Mini B USB port on the side of the casing (Fig. 54 **A**). Using the supplied A-Standard to B-Mini 5 pin flat USB cable (**B**), Testifire can be connected to a computer to allow software updates to be uploaded (**C**).
- Testifire should only be connected to personal computing equipment which complies with relevant safety and EMC standards.
- Only the Testifire-supplied USB 2.0 cable should be used to connect Testifire to a USB-enabled personal computer (PC).
- Firmware updates (available at: <http://www.testifire.com/site/technical/>) can be download to your Testifire unit by using the Testifire Flash Loader application (see **Section 7.7** for the Testifire Flash Loader Instructions).
- The Testifire Flash Loader End User Licence Agreement (EULA) can be found in **Section 10**.

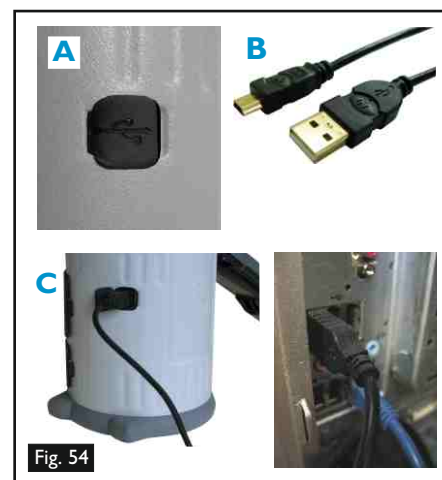

### 7.3 System Information

- To display the 'System Information', turn the unit on using the 'ON-OFF' key . Press the 'MENU' key to display the menu and use the 'UP' and 'DOWN' keys to navigate to the 'System Info.' (Fig. 55). Press the 'ENTER' key to access the system information menu (Fig. 56). Press the 'ESCAPE' key to return to the 'MAIN' menu.

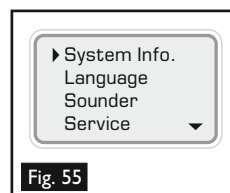

Fig. 55

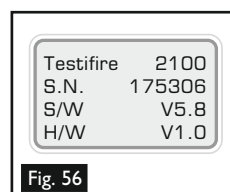
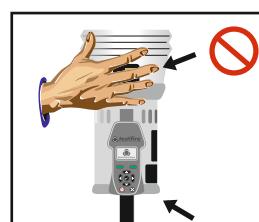

Fig. 56

### 7.4 Maintenance

- The Testifire unit contains no user serviceable parts.
- Do not disassemble.
- Do not block air vents.
- Use only capsules and batteries specified by the manufacturer.
- In the case of a build-up of dust or dirt on the surface of the product, wipe with a slightly damp lint-free cloth. Do not use detergents, cleaning materials or solvents to clean the product.



**DO NOT BLOCK  
AIR VENTS.**



**NO USER  
SERVICEABLE  
PARTS.**

## 7.5 Servicing

- To ensure that your Testifire unit continues to perform as intended, it is recommended that the unit is returned annually for a service.
- In some countries, Testifire will require an annual, traceable service in accordance with national or international standards for testing equipment.
- The service that **detectortesters, No Climb Products Ltd.** carries out uses equipment that is traceable in accordance with ISO9001.
- Testifire has a built-in service interval timer that will alert you when a service is due (Fig. 57) or overdue (Fig. 58).
- When Testifire is used extensively, a service may be required prior to 12 months. Testifire will notify you when a service is due or overdue.
- Please retain your original Testifire packaging and box, if you intend to return your Testifire for servicing.

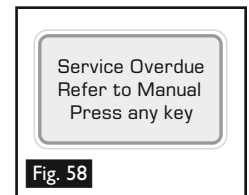
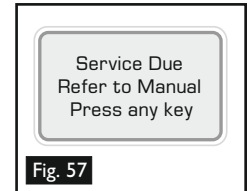

### What tasks are carried out as part of the Service, Calibration and Conformity Check (SCCC)?

With the release of the Mk2 Testifire, Service, Calibration and Conformity Check is carried out via exchange units. You will return your Testifire and an exchange replacement unit will be sent back to by return. Your new Testifire will be supplied with a Calibration and Conformity Certificate and 3 months warranty.

A Service, Calibration and Conformity Certificate will be provided auditing proof that all measurements were made using calibrated instruments and are traceable back to UKAS, National Standards or International Standards, except where none exist. The instrument was calibrated in accordance with the general requirements of ISO 10012:2003 and the Company Quality Management System to ISO 9001:2000 BRE Certification. Certificate No 813.

In accordance with requests from certain sectors of the world market, Testifire models 1000 and 2000 (from firmware version 5.4) now allows the user to turn off the Service notification screens. Anyone that is using an earlier firmware version and wishes to enable this option will need to carry out a Testifire firmware upgrade. Please see <http://www.testifire.com/site/technical/> for further information on Testifire firmware updates.

### What should I send back for Service, Calibration and Conformity Check?

Please return your Testifire (battery batons and charger are not covered by the Testifire service. Please make sure you include the Testifire inner cup.

Please send you Testifire and the above parts to your reseller.

## 7.6 Service Reminders

By default Testifire will notify the user when a Service is due or over due. If required the Service reminders can be turned off (Firmware version 5.4 or later).

To disable service reminders, press the 'MENU' key on the keypad and use the 'DOWN' key to navigate to 'Service' (Fig 61). Press the 'ENTER' key to select 'Service'. This will display the Service reminder control screen. (Fig 62). Press 'ENTER' key to turn off the Service reminders.

**Please Note:** The ability to turn off the Service Reminder Screens was added from firmware version 5.4 (issued Nov 2009).

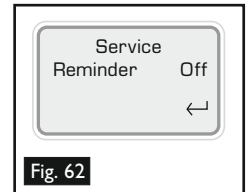
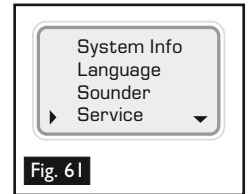

## 7.7 Testifire Flash Loader Software Instructions

For Testifire 1000 & 2000 Models



### Welcome to the Testifire Flash Loader Software

**Before connecting Testifire to the computer, first install the Flash Loader software.**

#### Introduction

Testifire Flash Loader is a free Windows based application that allows you to update your Testifire firmware on your Testifire without the need to return it for service.

The Flash Loader allows the user to upgrade Testifire to the latest firmware version via the computers USB port.

Before you can use the Testifire Flash Loader to update the firmware on your Testifire unit, you must first install the application and Testifire USB drivers. See the Installation instructions below.

The Testifire Flash Loader is intended to be used on a PC that is connected to the internet. It can be used without an Internet Connection as long as you have previously downloaded the appropriate Firmware binary file (this for advanced users). See [www.testifire.com/site/technical/](http://www.testifire.com/site/technical/)

**PLEASE READ THE INSTRUCTIONS BEFORE STARTING THE INSTALLATION.**

#### What is Firmware?

Firmware is a computer program that is embedded in a hardware device, in this case Testifire.

#### Why are updates required?

A Testifire Firmware update could provide either additional functionality and/or enhancements to existing features.

#### Requirements

Testifire Flash Loader Software  
Testifire USB Cable (A to mini B) -Part No: EA36176  
Fully charged battery  
Internet Connection \*

#### Supported

Windows 2000 Professional  
Windows XP x32  
Windows Vista x32  
USB V1.1 and USB V2.0

\* The Testifire Flash Loader has an automatic feature that allows it to connect to the Internet and download the latest Testifire firmware version. To enable it to this you must have a working internet connection.  
Advanced users may manually download a Testifire firmware binary file and manually apply without having access to the internet.

## Windows Vista -Testifire Device Driver Installation

### Step 1

Run the Flash Loader software and when prompted connect Testifire to the computer using the supplied USB cable.

The "Found New Hardware" wizard will launch.

### Step 2

Select "Locate and install driver software".

If the User Account control window appears, "Windows need your permission to continue", select continue.



**Step 3**

Select "I don't have the disc. Show me other options."



**Step 4**

Select "Browse my computer for driver software".



**Step 5**

The USB drivers are located in the install directory of the Testfire Flash Loader application.

This would usually be C:\Program Files\Testfire\Testfire Flash Loader\USB Drivers

Use the "Browse" button to select the directory where the drivers are located then click "Next".

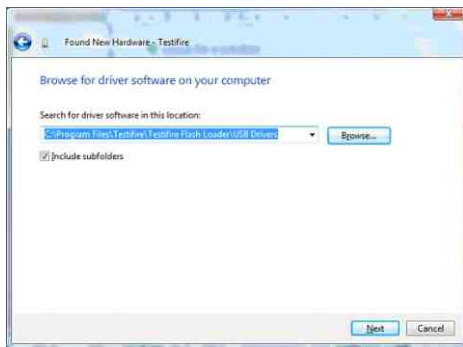

**Step 6**

This driver may not yet be digitally signed, however it Windows will now install the Testfire USB drivers. was obtained from either [www.testfire.com](http://www.testfire.com) or the disc Click "Close" to exit the wizard which was supplied with your Testfire then it is safe to use on your computer.

Select "Install this driver software anyway".



**Step 7**

Windows will now install the Testfire USB drivers. Click "Close" to exit the wizard.





# Windows XP -Testifire Device Driver Installation

## Step 1

Run the Flash Loader software and when prompted Select "Install from a list or specified location" and connect Testifire to the computer using the supplied then click "Next" to continue. USB cable.

The "Found New Hardware" wizard will launch.

## Step 2

Windows will now install the Testifire USB drivers. Click "Close" to exit the wizard.



## Step 3

Select "Install from a list or specified location" and then click "Next" to continue.



## Step 4

Select "Search for the best driver in these locations" and "Include this location in the search".

The USB drivers are located in the install directory of the Testifire Flash Loader application. This would usually be C:\Program Files\Testifire\Testifire Flash Loader\USB Drivers  
Use the "Browse" button to select the directory where the drivers are located then click "Next".

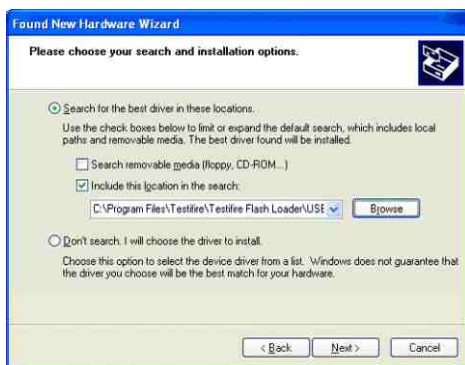

## Step 5

This driver may not yet be tested by Windows Logo testing, however if it was obtained from either [www.testifire.com](http://www.testifire.com) or the disc which was supplied with your Testifire then it is safe to use on your computer. Click "Continue Anyway".



## Step 6

Windows will now install the Testifire USB drivers. Click "Finish" to exit the wizard.



# Windows 2000 - Testfire Device Driver Installation

## Step 1

Run the Flash Loader software and when prompted connect Testfire to the computer using the supplied USB cable. The "Found New Hardware" wizard will launch.

## Step 2

Click "Next" to continue.



## Step 3

Select "Search for a suitable driver for my device" then click "Next" to continue.



## Step 4

Select "Specify a location" then click "Next" to continue.



## Step 5

The USB drivers are located in the install directory of the Testfire Flash Loader application.

This would usually be C:\Program Files\Testfire\Testfire Flash Loader\USB Drivers.

Use the "Browse" button to select the directory where the drivers are located then click "OK".



## Step 6

The Testfire driver should be identified. Click "Next" to install.



## Step 7

The Testfire driver should be identified. Click "Next" to install.



# Updating Your Testfire Firmware

 **Before connecting Testfire to the computer, first install the Flash Loader software.**

## Step 1

After installing the Testfire Flash Loader software, start the application from either the program menu or desk top icon.



## Step 2

Insert a fully charged battery into Testfire and then switch the unit on.



## Step 3

Connect the USB cable to Testfire and then to the computer. If the Testfire device drivers have not been previously installed the computer will launch the Found New Hardware Wizard. Please refer to the instructions in the Testfire Driver Installation Guide (link here) before installing the drivers. The drivers must be installed correctly before continuing.



## Step 4

The application will now scan the computers USB ports to detect the devices connected. This process should be instant and the screen below will be shown.



If the Testfire is not detected instantly, the scanning process will continue until either the Testfire is detected or the user clicks on Back or Cancel buttons.



Failure to detect the Testfire may be due to:  
The unit is not switched on.  
The USB cable is not connected correctly.  
The Testfire USB device drivers may not be installed correctly.  
The USB port on the computer may not be functioning.  
More than one Testfire is connected to the computer at the same time.



### Step 5

The next stage is to load the Testfire firmware file into the application.

Use the Open button to select a file stored on the computers hard disk or use the Download button to automatically download the latest firmware version from the Testfire website.

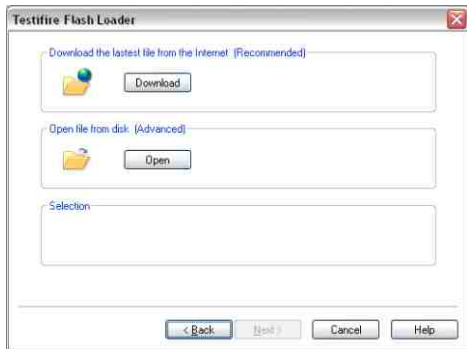

Once the file has been selected it is checked and the version number shown.



### Step 6

Now start the programming process by pressing the Program button. Testfire is switched into Boot Loader Mode automatically and the new firmware is loaded.

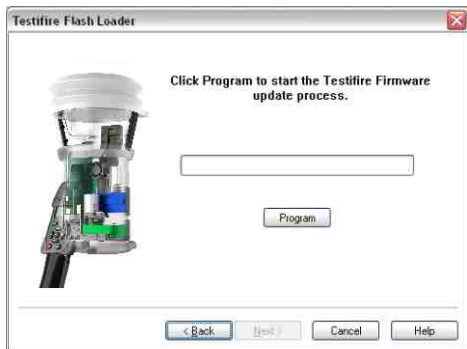

Do not interrupt programming or disconnect the USB cable. The progress bar is shown.

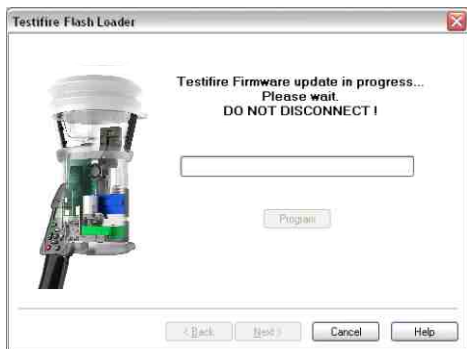

When programming is completed successfully the following screen is shown. Click on the Next button.

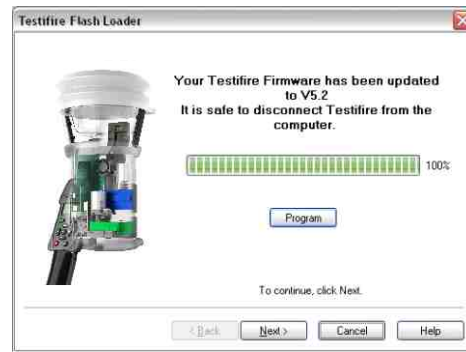

In the unlikely event that the programming process fails or programming is aborted by the user, Testfire remains in Boot Loader mode. Click on Cancel to exit the program. Then disconnect the USB cable and Battery Baton from Testfire. The programming process can then be repeated from Step 1.

Testfire will remain in Boot Loader mode until programmed successfully and can not be permanently damaged by this process.

When Testfire is powered up in Boot Loader mode, the screen remains blank and a double beep is sounded. This indicates the Testfire is working and can be programmed as normal from Step 1.

### Step 7

Exit the application by pressing Finish.



## Technical Support

### Contact us

If you experience any problems using the Testfire Flash Loader, do not hesitate to email us at [Support@Testfire.com](mailto:Support@Testfire.com)

In order for us to give you a quick and accurate solution please include:

- Description of problem, and how it can be replicated (if applicable).
- Your Operating system (Vista, XP or 2000) and localisation.
- Any other information you think may be helpful.

We will do our best to reply to you within two working days.

For additional information, visit the Testfire Support: [www.testfire.com](http://www.testfire.com)

## 8. Technical Specifications

Power source	Battery Baton: nominal 7.2V 2.2Ah NiMH rechargeable battery pack with internal overcurrent protection connects directly to Testifire with no leads or wires. Must be charged by Solo 726 Battery Charger (using 100-230VAC or 12VDC input).
Battery Charge Time	Approx. 90 mins. (if completely discharged).
Power consumption	Dependent on mode of use: Smoke testing: <0.5A rms Heat testing: 4-6A rms CO testing: 2-5A rms RFID/Bluetooth® : <150mA rms N.B. Power consumption refers only to the duration of the actual test and may vary considerably due to internal control algorithms.
Test modes	<b>Smoke:</b> a simulated smoke generated internally using a miniature heat exchanger and a harmless liquid from the smoke capsule. <b>Normal Heat:</b> to test rate-of-rise and fixed temperature heat detectors up to 90°C (194°F). <b>Hi Heat:</b> to test rate-of-rise and fixed temperature heat detectors up to 100°C (212°F). <b>Carbon Monoxide (CO):</b> CO is generated internally and blown into the detector at a concentration of approximately 100ppm (not calibrated). CARBON MONOXIDE (CO) IS A HARMFUL, ODOURLESS GAS AND CARE SHOULD BE TAKEN NOT TO INHALE DIRECTLY FROM THE DUCT DURING A CO TEST. <b>Clearing:</b> clean air is blown to remove previously applied Smoke or CO. <b>Simultaneous Testing:</b> Smoke, Heat and CO (if appropriate) in any combination as programmed by the user are all carried out in one test. <b>Sequential Testing:</b> Tests are performed according to the order that they have been programmed by the user. <b>RFID Auto Mode:</b> Automatic testing using an RFID module fitted to Testifire and an appropriately programmed RFID label attached to the detector.
Safety Features	Battery over-current cut-out. Default 2 minutes maximum test duration timeout. Auto power off after 10 minutes of non-use. CO generated on demand (no gas stored).
Operating Features	Colour coded LED user feedback. Automatic infrared sensing of the detector. Adjustable multi-position head. Optional fully-automatic configuration (RFID Auto mode).
Suitable Detector Types	Optical / photoelectric and ionisation smoke detectors. Thermal sensors (fixed temperature or rate-of-rise). Carbon Monoxide (CO) fire sensors. Multi-sensors or multi-criteria detectors. Conventional, addressable or analogue addressable detectors of any of the above types.
Environment	Operating temperature range: +5°C to +45°C (41°F to 113°F). Operating humidity range: 0 to 85% RH non-condensing. Storage temperature range: -10°C to +50°C (14°F to 122°F). Storage humidity range: 0 to 90% RH non-condensing (up to +35°C / 95°F).
IP Rating	Rated according to IEC60529 to IP20.

Weights	Testifire 1000: 990g (including Battery Baton) Testifire 2000: 1.23kg (including Battery Baton) Solo 760 Battery Baton: 0.5kg
Dimensions	Testifire 1000: Bellows width: 153mm max. Head Unit height: 224mm max. (397mm including handle) Testifire 2000: Bellows width: 153mm max. Head Unit height: 273mm max. (397mm including handle)

**Note:** Product specifications may be subject to change without prior notice or obligation on the part of the manufacturer.

#### International Patents

Testifire is protected by the following patents and has patents applied for:

Patents: EP(FR,GB)091055B, DE69820382.8, ZL98120414.7, US6423962, EP(FR,GB)1290661B, DE60112442.1, ZL01801074.1, US6640608, HK1065150, EP(FR,GB)1390927B, DE50205116.7, DE60314594.9, GB2385179B, GB2409319B.

Patents Applied for: US10/503745, EP1794728A, WO 2007/015045, WO 2007/060447, GB2432703A

## 8.1 Field Replaceable Parts

Use only approved accessories that are recommended by the manufacturer for your Testifire model.  
(see Section 9.1)

Testifire does not contain any field serviceable parts. The following spare and consumable parts are available to order from your distributor:

- TS3 Smoke Capsule 3 pack - TS3-3PACK-001
- TS3 Smoke Capsule 6 pack - TS3-6PACK-001
- TC3 CO Capsule 3 pack - TC3-3PACK-001
- TC3 CO Capsule 6 pack - TC3-6PACK-001
- Membrane - SPARE-1049-001
- Inner Cup - SPARE-1048-001
- USB Cable - SPARE-1047-001
- Battery Baton - Solo 760-001
- Charger - Solo 726-001

# 9. Product Selector

## Products



**testifire 1000**



**testifire 2000**



**testifire TS3**



**testifire TC3**



**testifire 1001**



**testifire 2001**



**testifire 6001**



**testifire 6201**



**testifire 9001**



**testifire 9201**

Application						Accessories				Access	
Smoke Testing	Heat Testing	CO Testing	Smoke/Heat Testing	Smoke/Heat/CO Testing	ASD Testing	Battery Baton	Universal Fast Charger	Removal Tool	Protective Carrying Bag	Access Height up to 6m	Access Height up to 9m
●	●		●		●						
●	●	●	●	●	●						
●											
		●									
●	●		●		●	● (x 2)	●				
●	●	●	●	●	●	● (x 2)	●				
●	●		●		●	● (x 2)	●	●	●	● (Solo 100 x 1)	
●	●	●	●	●	●	● (x 2)	●	●	●	● (Solo 100 x 1)	
●	●		●		●	● (x 2)	●	●	●		● (Solo 100 + Solo 101 x 3)
●	●	●	●	●	●	● (x 2)	●	●	●		● (Solo 100 + Solo 101 x 3)

## Accessories



**Testifire 25**



**Solo 200**



**Solo 760**



**Solo 726**



**Solo 100**



**Solo 101**



**Solo 610**

Infrared Remote Control	Universal Battery Baton	Fast Charger	Removal Tool	Protective Carrying Bag	Access Height up to 6m	Access Height up to 9m
●						
			●			
	●					
		●				
					● (Solo 100 x 1)	
						● (Solo 100 + Solo 101 x 3)
				●		

### Solo Poles Access Height

Solo™ Model No.	Access Height (approx. max.)
100	6m (20ft)
100+101 (1)	7m (23ft)
100+101 (2)	8m (26.25ft)
100+101 (3)	9m (30ft)

# 10. Agreement for Supply of Products and Associated Software

## IMPORTANT NOTICE: PLEASE READ CAREFULLY BEFORE EITHER:

### (A) DOWNLOADING ANY SOFTWARE FROM THIS WEBSITE, OR (B) OPENING THE PACKAGING, OR (C) INSTALLING THE SOFTWARE:

This Agreement for Supply of Products and Software (Agreement) is a legal agreement between you (Licensee or you) and No Climb Products Limited (Licensor or we) for (i) the Licensor's Product and (ii) all related software and all future upgrades thereto (Software). This Agreement also applies to any data supplied with the Software, associated media, printed materials and related documentation.

#### (Documentation).

BY PROCEEDING TO DOWNLOAD ANY SOFTWARE FROM THIS WEBSITE OR INSTALLING THIS SOFTWARE OR CLICKING ON THE "ACCEPT" BUTTON OR OPENING THE PACKAGING YOU AGREE TO THE TERMS OF THIS AGREEMENT WHICH WILL BIND YOU AND YOUR EMPLOYEES.

## DEFINITIONS

Licensor's Products are products that are supplied on commercial terms by the Licensor and with which the Software interacts; Website refers to the website from which Licensor makes the Software or upgrades to the software available for download to you;

### 1. GRANT AND SCOPE OF AGREEMENT

1.1 In consideration of you agreeing to abide by the terms of this Agreement, the Licensor hereby grants to you a non-exclusive, non-transferable Agreement to use the Software and the Documentation solely in conjunction with the Licensor's Products on the terms of this Agreement.

#### 1.2 You may:

(a) download, install and use the Software for your private OR internal business purposes only, in relation to the Licensor's Products;  
(b) make copies of the Software where this is necessary for the activities permitted under condition 2.1(a);  
SRH/SM/SM/573.4/502256.8

(c) receive and use any free supplementary software code or update of the Software incorporating "patches" and corrections of errors in non-source code format as may be provided by the Licensor from time to time;

(d) receive and use any free supplementary software code or update of the Software incorporating "patches" and corrections of errors in source code format as may be provided by the Licensor from time to time. Where software is received in source code format, clauses 2.1(d), 2.1(e), 3.2, 3.3, shall not apply.

(e) use any Documentation in support of the use permitted under condition 1.1 and make copies of the Documentation as are reasonably necessary for its lawful use

## 2. LICENSEE'S UNDERTAKINGS

2.1 Except as expressly set out in this Agreement or as permitted by any local law, you undertake:

- (a) not to copy the Software or Documentation except where such copying is incidental to normal use of the Software, or where it is necessary for the purpose of back-up or operational security;
- (b) not to rent, lease, sub-license or loan, the Software or Documentation;
- (c) not to translate, merge, adapt, vary or modify the Software or Documentation;
- (d) not to make alterations to, or modifications of, the whole or any part of the Software, nor permit the Software or any part of it to be combined with, or become incorporated in, any other programs;
- (e) not to disassemble, decompile, reverse engineer or create derivative works based on, the whole or any part of the Software nor attempt to do any such things except to the extent that (by virtue of section 296A of the Copyright, Designs and Patents Act 1988) such actions cannot be prohibited because they are essential for the purpose of achieving inter-operability of the Software with another software program, and provided that the information obtained by you during such activities:
  - (i) is used only for the purpose of achieving inter-operability of the Software with another software program; and
  - (ii) is not unnecessarily disclosed or communicated without the Licensor's prior written consent to any third party; and
  - (iii) is not used to create any software which is substantially similar to the Software; SRH/SM/SM/573.4/502256.8
- (f) to keep all copies of the Software secure and to maintain accurate and up-to-date records of the number and locations of all copies of the Software;
- (g) to supervise and control use of the Software and ensure that the Software is used by your employees and representatives in accordance with the terms of this Agreement;
- (h) to replace the current version of the Software with any updated or upgraded version or new release provided by the Licensor under the terms of this Agreement immediately on receipt where the Licensor specifically recommends that you do so;
- (i) to include the copyright notice of the Licensor on all entire and partial copies you make of the Software on any medium;
- (j) not to provide or otherwise make available the Software in whole or in part (including but not limited to program listings, object and source program listings, **object code and source code**), **in any form to any person [other than your employees] without prior written consent from the Licensor;**

2.2 You must permit the Licensor and his representatives, at all reasonable times and on reasonable advance notice, to inspect and have access to any premises at which the Software or the Documentation is being kept or used, to the computer equipment located there, and to any records kept pursuant to this Agreement, for the purpose of ensuring that you are complying with the terms of this Agreement.

## 3. INTELLECTUAL PROPERTY RIGHTS

3.1 You acknowledge that all intellectual property rights in the Software and the Licensor's Products and the Documentation anywhere in the world belong to the Licensor, that rights in the Software are licensed (not sold) to you, and that you have no rights in, or to, the Software or the Documentation other than the right to use them in accordance with the terms of this Agreement.

3.2 You acknowledge that you have no right to have access to the Software in source code form or in unlocked coding or with comments.

3.3 The integrity of this Software, or any future upgrade of this software, may at any time be protected by technical protection measures (TPM) so that the intellectual property rights, including copyright, in the Software of the Licensor are not misappropriated. You must not attempt in any way to remove or circumvent any such TPM, nor apply or manufacture for sale or hire, import, distribute, sell or let for hire, SRH/SM/SM/573.4/502256.8 offer or expose for sale or hire, advertise for sale or hire or have in your possession for private or commercial purposes any means the sole intended purpose of which is to facilitate the unauthorised removal or circumvention of such TPM.



### 3. INTELLECTUAL PROPERTY RIGHTS

**3.1** You acknowledge that all intellectual property rights in the Software and the Licensor's Products and the Documentation anywhere in the world belong to the Licensor, that rights in the Software are licensed (not sold) to you, and that you have no rights in, or to, the Software or the Documentation other than the right to use them in accordance with the terms of this Agreement.

**3.2** You acknowledge that you have no right to have access to the Software in source code form or in unlocked coding or with comments.

**3.3** The integrity of this Software, or any future upgrade of this software, may at any time be protected by technical protection measures (TPM) so that the intellectual property rights, including copyright, in the Software of the Licensor are not misappropriated. You must not attempt in any way to remove or circumvent any such TPM, nor apply or manufacture for sale or hire, import, distribute, sell or let for hire, SRH/SM/SM/573.4/502256.8 offer or expose for sale or hire, advertise for sale or hire or have in your possession for private or commercial purposes any means the sole intended purpose of which is to facilitate the unauthorised removal or circumvention of such TPM.

### 4. WARRANTY

**4.1** The Licensor warrants that:

For a period of 90 days from the date of purchase, installation or download as the case may be (Warranty Period) the Licensor's Products and Software will, when properly used, perform substantially in accordance with the functions described in the Documentation;

**4.2** You acknowledge that the Software has not been developed to meet your individual requirements, and that it is therefore your responsibility to ensure that the facilities and functions of the Software as described in the Documentation meet your requirements.

**4.3** You acknowledge that the Software may not be free of bugs or errors, and agree that the existence of minor errors shall not constitute a breach of this Agreement.

**4.4** If, within the Warranty Period, you notify the Licensor in writing of any defect or fault in the Software in consequence of which it fails to perform substantially in accordance with the Documentation, and such defect or fault does not result from you having amended the Software or used it in contravention of the terms of this Agreement, the Licensor will, at its sole option, either repair or replace the Software, provided that you make available all the information that may be necessary to help the Licensor to remedy the defect or fault, including sufficient information to enable the Licensor to recreate the defect or fault.

### 5. LICENSOR'S LIABILITY

**5.1** Nothing in this Agreement shall exclude or in any way limit the Licensor's liability for fraud, or for death or personal injury caused by its negligence, or any other liability to the extent that it may not be excluded or limited as a matter of law.

**5.2** Subject to condition 5.1 the Licensor shall not be liable under, or in connection with, this Agreement or any collateral contract for:

(a) loss of income;

SRH/SM/SM/573.4/502256.8

(b) loss of business profits or contracts;

(c) business interruption;

(d) loss of the use of money or anticipated savings;

(e) loss of information;

(f) loss of opportunity, goodwill or reputation;

(g) loss of, damage to or corruption of data; or

(h) any indirect or consequential loss or damage of any kind howsoever arising and whether caused by tort (including negligence), breach of contract or otherwise; provided that this condition 5.2 shall not prevent claims for loss of or damage to your tangible property that fall within the terms of condition 4 or any other claims for direct financial loss that are not excluded by any of categories (a) to (h) inclusive of this condition 5.2.

**5.3** Subject to condition 5.1 and condition 5.2, the Licensor's maximum aggregate liability under or in connection with this Agreement, or any collateral contract, whether in contract, tort (including negligence) or otherwise, shall be limited to a sum equal to 100% of the price of the related Licensor's Products and Software giving rise to liability.

**5.4** Subject to condition 5.1, condition 5.2 and condition 5.3, the Licensor's liability for infringement of third-party intellectual property rights shall be limited to breaches of rights subsisting in the UK.

**5.5** This Agreement sets out the full extent of the Licensor's obligations and liabilities in respect of the supply of the Licensor's Products, Software and Documentation. In particular, there are no conditions, warranties, representations or other terms, express or implied, that are binding on the Licensor except as specifically stated in this Agreement. Any condition, warranty, representation or other term concerning the supply of the Licensor's Products, Software and Documentation which might otherwise be implied into, or incorporated in, this Agreement, or any collateral contract, whether by statute, common law or otherwise, is hereby excluded to the fullest extent permitted by law.

SRH/SM/SM/573.4/502256.8

### 6. TERMINATION

**6.1** The Licensor may terminate this Agreement immediately by written notice to you if:

(a) You commit a material or persistent breach of this Agreement which you fail to remedy (if remediable) within 14 days after the service of written notice requiring you to do so; or

(b) a petition for a bankruptcy order to be made against you has been presented to the court; or

(c) the Licensee (where it is a company) becomes insolvent or unable to pay its debts (within the meaning of section 123 of the Insolvency Act 1986), enters into liquidation, whether voluntary or compulsory (other than for reasons of bona fide amalgamation or reconstruction), passes a resolution for its winding-up, has a receiver or administrator manager, trustee, liquidator or similar officer appointed over the whole or any part of its assets, makes any composition or arrangement with its creditors or takes or suffers any similar action in consequence of its debt, unable to pay your debts (within the meaning of section 123 of the Insolvency Act 1986).

**6.2** Upon termination for any reason:

(a) all rights granted to you under this Agreement shall cease;

(b) you must cease all activities authorised by this Agreement;

(c) you must immediately pay to the Licensor any sums due to the Licensor under this Agreement; and

(d) you must immediately delete or remove the Software from all computer equipment in your possession, and immediately destroy or return to the Licensor (at the Licensor's option) all copies of the Software then in your possession, custody or control and, in the case of destruction, certify to the Licensor that you have done so.

## 7. TRANSFER OF RIGHTS AND OBLIGATIONS

**7.1** This Agreement is binding on you and us, and on our respective successors and assigns.  
SRH/SM/SM/573.4/502256.8

**7.2** You may transfer, assign, charge or otherwise dispose of this Agreement, or any of your rights or obligations arising under it, without our prior written consent provided that the beneficiary of any such any transfer, assignment, charge or disposal must have agreed to abide by the terms of this Agreement prior to or at the time of any such transfer, assignment, charge or disposal. The transfer, assignment, charge or disposal must include all copies of all versions (including but not limited to the most recent version) of the Software as well as all copies of the Documentation and all accompanying instances of the Licensor's Products.

**7.3** We may transfer, assign, charge, sub-contract or otherwise dispose of this Agreement, or any of our rights or obligations arising under it, at any time during the term of the Agreement.

## 8. NOTICES

All notices given by you to us must be given to No Climb Products Limited at Edison House, 163 Dixons Hill Road, Welham Green, Hertfordshire, AL9 7JE. We may give notice to you at either the e-mail or postal address you provided to us OR our representative when purchasing the Software. Notice will be deemed received and properly served immediately when posted on our website, 24 hours after an e-mail is sent, or three days after the date of posting of any letter. In proving the service of any notice, it will be sufficient to prove, in the case of a letter, that such letter was properly addressed, stamped and placed in the post and, in the case of an e-mail, that such e-mail was sent to the specified e-mail address of the addressee.

## 9. EVENTS OUTSIDE OUR CONTROL

**9.1** We will not be liable or responsible for any failure to perform, or delay in performance of, any of our obligations under this Agreement that is caused by events outside our reasonable control (Force Majeure Event).

**9.2** A Force Majeure Event includes any act, event, non-happening, omission or accident beyond our reasonable control and includes in particular (without limitation) the following:

- (a) strikes, lock-outs or other industrial action;
  - (b) civil commotion, riot, invasion, terrorist attack or threat of terrorist attack, war (whether declared or not) or threat or preparation for war;
  - (c) fire, explosion, storm, flood, earthquake, subsidence, epidemic or other natural disaster;
  - (d) impossibility of the use of railways, shipping, aircraft, motor transport or other means of public or private transport;
  - (e) impossibility of the use of public or private telecommunications networks;
  - (f) the acts, decrees, legislation, regulations or restrictions of any government.
- 9.3** Our performance under this Agreement is deemed to be suspended for the period that the Force Majeure Event continues, and we will have an extension of time for performance for the duration of that period. We will use our reasonable endeavours to bring the Force Majeure Event to a close or to find a solution by which our obligations under this Agreement may be performed despite the Force Majeure Event.

## 10. WAIVER

**10.1** If we fail, at any time during the term of this Agreement, to insist upon strict performance of any of your obligations under this Agreement, or if we fail to exercise any of the rights or remedies to which we are entitled under this Agreement, this shall not constitute a waiver of such rights or remedies and shall not relieve you from compliance with such obligations.

**10.2** A waiver by us of any default shall not constitute a waiver of any subsequent default.

**10.3** No waiver by us of any of these terms and conditions shall be effective unless it is expressly stated to be a waiver and is communicated to you in writing.

## 11. SEVERABILITY

If any of the terms of this Agreement are determined by any competent authority to be invalid, unlawful or unenforceable to any extent, such term, condition or provision will to that extent be severed from the remaining terms, conditions and provisions which will continue to be valid to the fullest extent permitted by law.

SRH/SM/SM/573.4/502256.8

## 12. ENTIRE AGREEMENT

**12.1** This Agreement and any document expressly referred to in it represents the entire agreement between us in relation to the licensing of the Software and Documentation and supersedes any prior agreement, understanding or arrangement between us, whether oral or in writing.

**12.2** We each acknowledge that, in entering into this Agreement, neither of us has relied on any representation, undertaking or promise given by the other or be implied from anything said or written in negotiations between us prior to entering into this Agreement except as expressly stated in this Agreement.

**12.3** Neither of us shall have any remedy in respect of any untrue statement made by the other, whether orally or in writing, prior to the date we entered into this Agreement (unless such untrue statement was made fraudulently) and the other party's only remedy shall be for breach of contract as provided in these terms and conditions.

## 13. LAW AND JURISDICTION

This Agreement is governed by English law. Any dispute arising from, or related to, any term of this Agreement shall be subject to the exclusive jurisdiction of the courts of England and Wales.

As our policy is one of continuous improvement, details of products described within this publication are subject to change without notice. All information provided here is believed to be correct at the time of going to press. Every effort has been made to ensure the accuracy of information which is provided in good faith but nothing contained herein is intended to incorporate any representation or warranty, either express or implied or to form the basis of any legal relations between the parties hereto, additional to or in lieu of such as may be applicable to a contract of sale or purchase.

**Copyright Notice:** All Rights Reserved. No part of these written materials may be reproduced or used in any form or by any means, electronic or mechanical, including photocopying without the prior written permission of **detectortesters, No Climb Products Ltd.**

No liability is assumed with the respect to the use of information contained in these written materials or software, or for damages resulting from use of the information contained therein.

**No Climb Products Ltd**

Edison House  
163 Dixons Hill Road  
Welham Green  
Hertfordshire AL9 7JE  
United Kingdom

Tel: +44 (0) 1707 282 760  
Fax: +44 (0) 1707 282 777

info@detectortesters.com



**detectortesters**

*testing technology from No Climb*

[www.testifire.com](http://www.testifire.com)

GB LI32350-1